

OUTDOOR

4	Introduzione
6	Tailor made
8	Shire
60	T-soft
74	Carla
78	Simple
102	Sunset
106	Easy Table
114	Pure
138	Java
150	Briccola
158	Fusion
170	Blend
176	Sedia Y
182	Panama
186	Wunderkammer collection
196	Calypso
202	Hug
210	Jalan 1
218	Jalan 2
228	Basic 2
	Ombrelloni

L'arredo per esterno è oggi vissuto come un prodotto di pari rilevanza all'arredo degli interni. Il giardino o la terrazza, luoghi di incontro, di relax e di benessere rappresentano la punta di diamante della proposta di una struttura alberghiera e permettono agli ospiti di trascorrere parte del tempo all'aperto, circondati da ambienti dal forte impatto emozionale.

Outdoor furniture today holds the same importance as interior furniture. The garden and the terrace - places for meeting, relax and well-being - represent a strong point of hotels and resorts, allowing guests to spend part of their time in the open air in pleasant surroundings.

Outdoor-Möbel haben heutzutage die gleiche Wertigkeit wie ein Indoor-Möbel. Der Garten oder die Terrasse ist ein Ort des Zusammentreffens, der Entspannung und des Wohlbefindens und stellt einen wichtigen Punkt im Angebot der Gaststruktur dar. Es ist der Ort, an dem die Gäste einen Teil ihrer Zeit im Freien und umgeben eines hochemotionalen Ambientes verbringen.



SchönhuberFranchi

Tailor made

I prodotti proposti da SchönhuberFranchi in questo catalogo sono caratterizzati da un carattere individuale, una nota distintiva che è in grado di catturare il gusto e l'attenzione di cui si è alla ricerca.

La produzione arredo di SchoenhuberFranchi è inoltre in grado di sviluppare prodotti ad un alto tasso di personalizzazione in diversi materiali: legno, metallo, elementi tessili.

Punto d'avvio del progetto custom made è il dialogo con l'architetto e il cliente.

Un momento di confronto fondamentale, nel quale vengono lanciati stimoli e idee che, dopo la definizione del layout, tecnici e artigiani eseguono con materiali selezionati.

The items proposed by SchönhuberFranchi in this catalogue are distinguished by an individual character, a distinctive note that is capable of capturing the taste and attention of those searching.

SchoenhuberFranchi's furniture production is furthermore able to develop products of a high rate of personalisation in diverse materials: wood, metal, fabric, textile elements.

The starting point of the custom made project is the dialogue between the architect and the client.

A fundamental moment of confrontation, in which stimuli and ideas are exchanged which following the definition of the layout, technicians and craftsmen carry out with the chosen materials.

Die Produkte von Schönhuber Franchi in diesem Katalog punkten mit individuellem Charakter. Sie stehen für einen unverwechselbaren Stil und erregen mühelos Aufmerksamkeit. Die Möbel von Schönhuber Franchi können auch mit unterschiedlichen Materialien wie Holz, Metall und textilen Elementen personalisiert werden. Voraussetzung für das „custome made“ ist der Austausch von Ideen und Visionen zwischen dem Architekten und dem Kunden. Nach der Festlegung des Designs machen sich Techniker und Handwerker mit ausgewählten Materialien an die Umsetzung.



Shire

Design Piero Lissoni

Shire è la nuova collezione per l'outdoor SchönhuberFranchi, disegnata da Piero Lissoni. Il suo nome evoca le contee inglesi e la loro campagna: i grandi spazi verdi, le feste all'aperto, i campi da golf e le corse dei cavalli. Le forme sono sinuose e rimandano a sedute di altri tempi mentre le cinghie che sostengono e caratterizzano le poltroncine e le sedie conferiscono un tocco contemporaneo.

Shire is the new collection of outdoor SchönhuberFranchi's furniture designed by Piero Lissoni. The name concerns to the English counties with their lands and remember the beautiful outdoor parties, the endless green areas, golf courses and horses racing. The forms are sinuous and recall seats of bygone days whilst the straps, which support and characterize the armchairs and chairs, confer a contemporary touch.

Shire ist die neue Outdoor-Kollektion von Schönhuber Franchi aus der Feder von Architekt Piero Lissoni. Der Name dient als Anlehnung an die englischen Grafschaften und ihren Ländereien und soll an die prunkvollen Feste im Freien, die unendlichen Grünflächen, die Golfplätze und die Pferderennbahnen erinnern. Sinnliche Formen im Restyle und Lederriemen verleihen den Möbeln einen individuellen und doch zeitgemäßen Charakter.

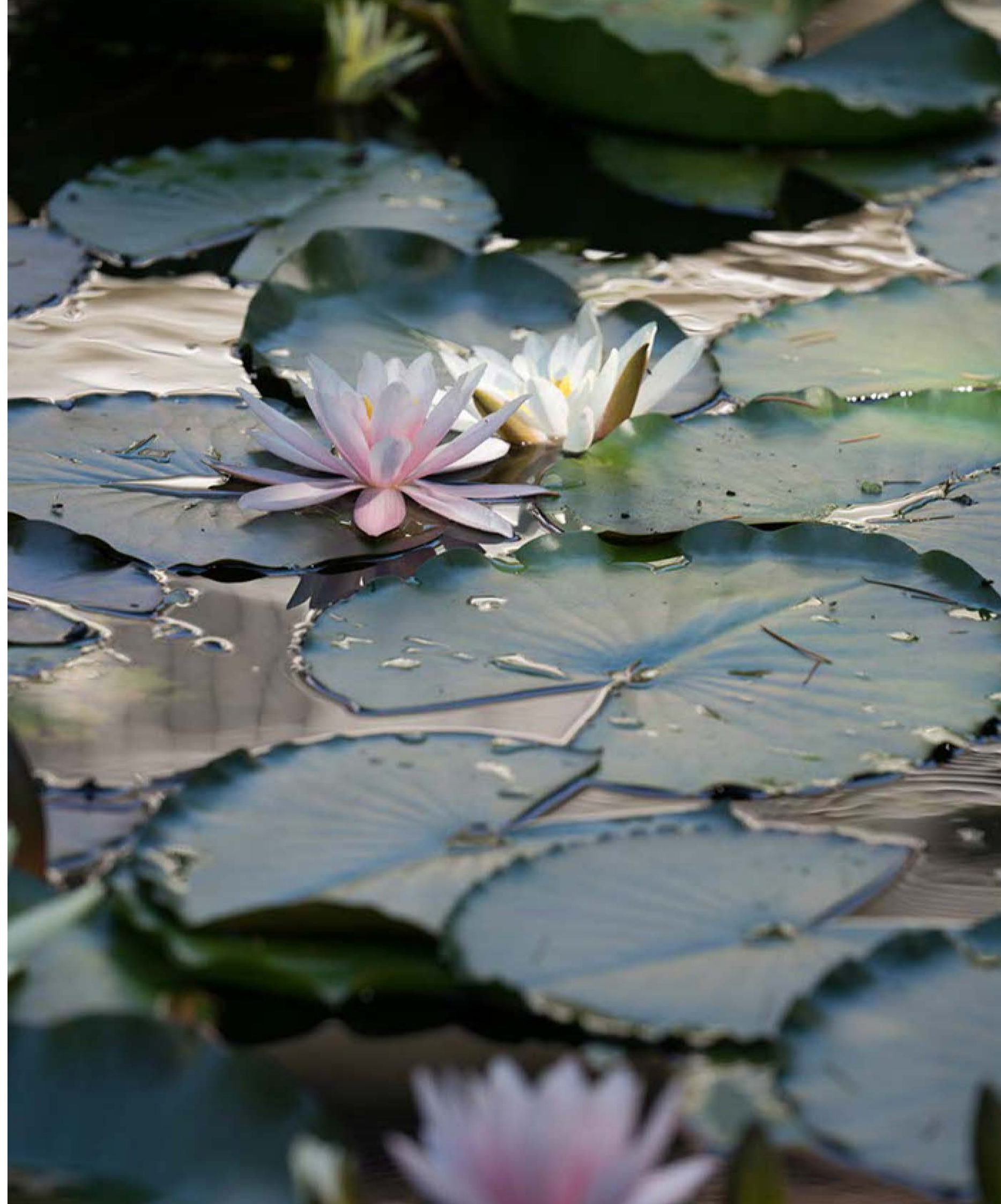



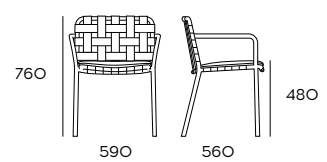

Sedia con braccioli
chair with arms, stuhl mit Armlehnen

COLORS	MATERIALS	CODE
nero, black, schwarz	metallo verniciato painted metal, lackiertes Metall	C5600301
bianco, white, weiß	polipropilene, polypropylene, Polypropylen	C5600302

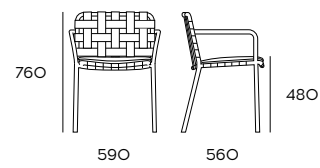

Sedia con braccioli
chair with arms, Stuhl mit Armlehnen

COLORS	MATERIALS	CODE
marrone, brown, braun	metallo verniciato painted metal, lackiertes Metall	C560037
rosso, red, rot		C560033
blu, blue, blau	polipropilene, polypropylene, Polypropylen	C560035
grigio canna di fucile, gray, grau		C560038

Cuscini
pillow, Kissen

FABRIC	CODE
classe A	C56003CUA
classe B	C56003CUB
classe C	C56003CUC

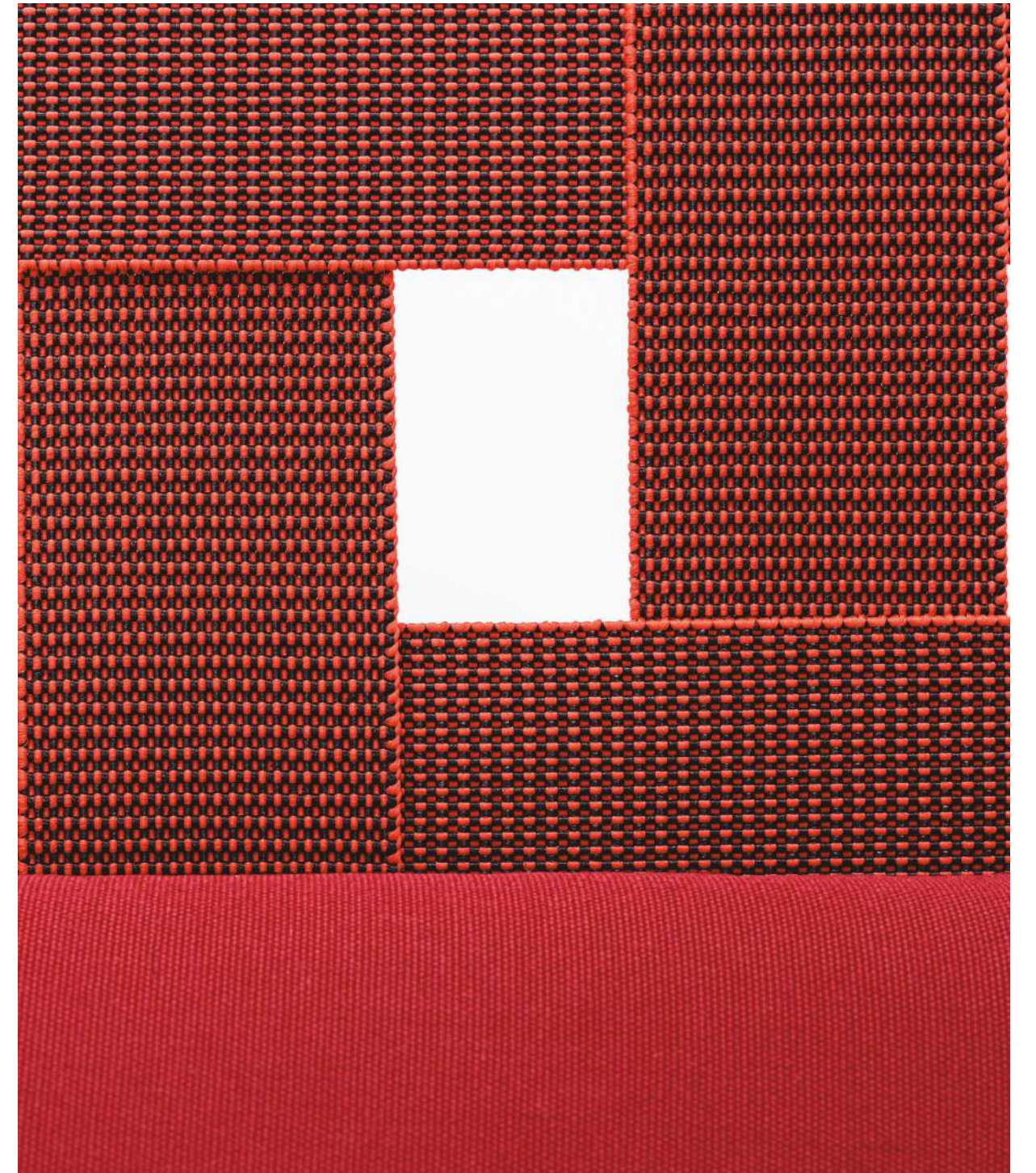



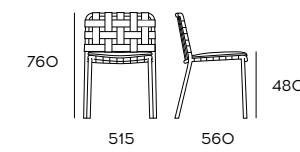
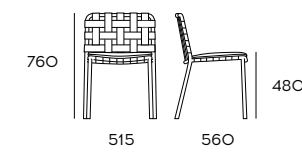

Sedia
chair, stuhl

COLORS	MATERIALS	CODE
nero, black, schwarz	metallo verniciato painted metal, lackiertes Metall	C5600201
bianco, white, weiß	polipropilene, polypropylene, Polypropylen	C5600202

Sedia
chair, Stuhl

COLORS	MATERIALS	CODE
marrone, brown, braun	metallo verniciato painted metal, lackiertes Metall	C560027
rosso, red, rot		C560023
blu, blue, blau	polipropilene, polypropylene, Polypropylen	C560025
canna di fucile, gray, grau		C560028

Cuscini
pillow, kissen

FABRIC	CODE
classe A	C56002CUA
classe B	C56002CUB
classe C	C56002CUC

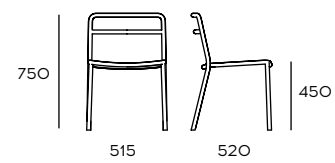

Sedia
chair, stuhl

MATERIALS	COLORS/FINISHES	CODE
metallo verniciato, painted metal, lackiertes Metall	su richiesta on request auf Anfrage	C56002M

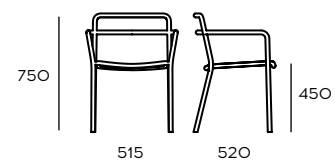

Sedia con braccioli
 chair with arms, stuhl mit Armlehnen

MATERIALS	COLORS/FINISHES	CODE
metallo verniciato painted metal lackiertes Metall	su richiesta on request auf Anfrage	C56003M



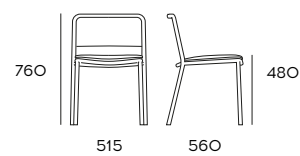

Sedia
chair, stuhl

COLORS	MATERIALS	CODE
nero, black, schwarz	metallo verniciato con rivestimento in batyline, painted black metal with batyline coating, schwarz lackiertes Metall mit Batyline-Beschichtung	C5620201
bianco, white, weiß		C5620202

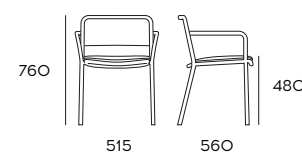

Sedia con braccioli
chair with arms, Stuhl mit Armlehnen

COLORS	MATERIALS	CODE
nero, black, schwarz	metallo verniciato con rivestimento in batyline, painted black metal with batyline coating, schwarz lackiertes Metall mit Batyline-Beschichtung	C5620301
bianco, white, weiß		C5620402



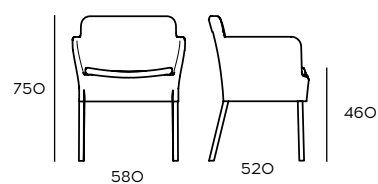
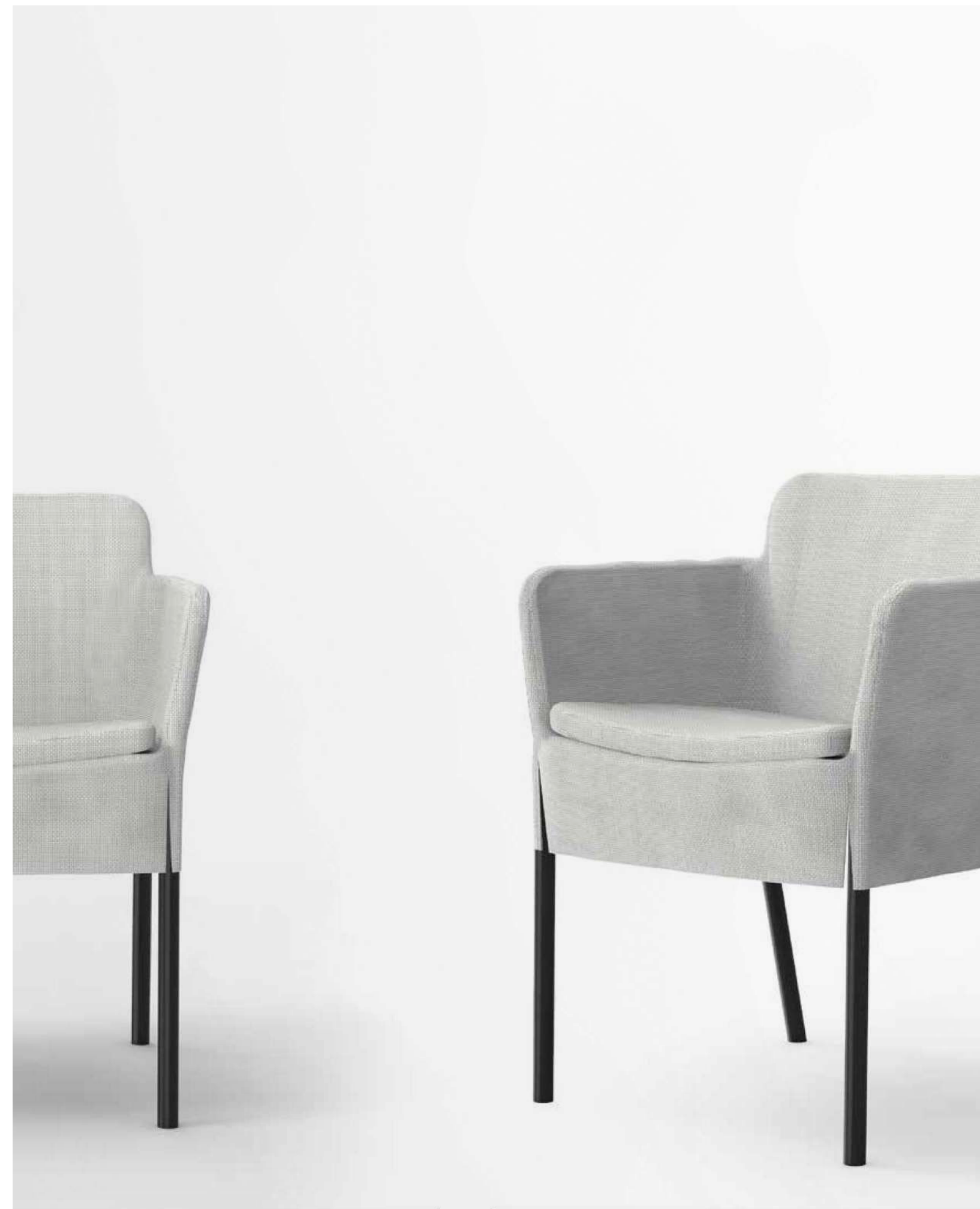

Rivestimento e cuscino per sedia con braccioli
upholstery and cushion for chair with armrests,
Polsterung und Kissen für Stuhl mit Armlehnen

MATERIALS	COLORS/FINISHES	FABRIC	CODE
tessuto fabric Stoff	su richiesta on request auf Anfrage	CLASSE A	C56003RA
		CLASSE B	C56003RB
		CLASSE C	C56003RC

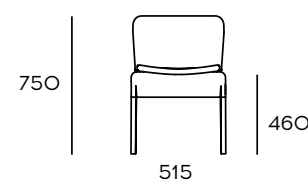

Rivestimento e cuscino per sedia
upholstery and cushion for chair,
Polsterung und Kissen für Stuhl

MATERIALS	COLORS/FINISHES	FABRIC	CODE
tessuto fabric Stoff	su richiesta on request auf Anfrage	CLASSE A	C56002RA
		CLASSE B	C56002RB
		CLASSE C	C56002RC



Rivestimento e cuscino per divano
 upholstery and cushion for chair with armrests, Sofabezug und Kissen

MATERIALS	COLORS/FINISHES	FABRIC	CODE
tessuto fabric Stoff	su richiesta on request auf Anfrage	CLASSE A	C56004RA
		CLASSE B	C56004RB
		CLASSE C	C56004RC

Kit n° 4 rialzi per divano
 Kit of 4 sofa risers,
 Kit mit 4 Sofaerhöhungen

CODE
C56004KIT

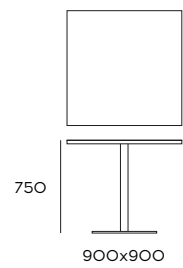

Tavolo quadrato con base tonda
square table with round base, quadratischer Tisch mit runder Grundfläche

COLORS	MATERIALS	CODE
nero, black, schwarz	metallo verniciato, painted metal, lackiertes Metall	C5600701
bianco, white, weiß	piano hpl, top hpl, tischplatte hpl	C5600702

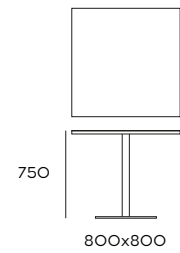

Tavolo quadrato con base tonda
square table with round base, quadratischer Tisch mit runder Grundfläche

COLORS	MATERIALS	CODE
nero, black, schwarz	metallo verniciato, painted metal, lackiertes Metall	C5601101
bianco, white, weiß	piano hpl, top hpl, tischplatte hpl	C5600102

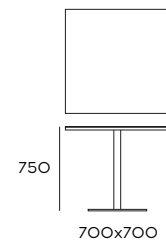

Tavolo quadrato con base tonda
square table with round base, quadratischer Tisch mit runder Grundfläche

COLORS	MATERIALS	CODE
nero, black, schwarz	metallo verniciato, painted metal, lackiertes Metall	C5601601
bianco, white, weiß	piano hpl, top hpl, tischplatte hpl	C5601104

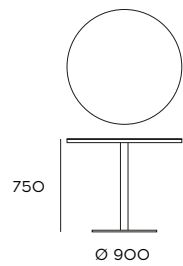

Tavolo tondo con base tonda
round table with round base, rund Tisch mit runder Grundfläche

COLORS	MATERIALS	CODE
nero, black, schwarz	metallo verniciato, painted metal, lackiertes Metall	C5600705
bianco, white, weiß	piano hpl, top hpl, tischplatte hpl	C5600706

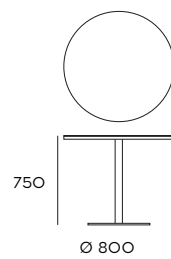

Tavolo tondo con base tonda
round table with round base, rund Tisch mit runder Grundfläche

COLORS	MATERIALS	CODE
nero, black, schwarz	metallo verniciato, painted metal, lackiertes Metall	C5601103
bianco, white, weiß	piano hpl, top hpl, tischplatte hpl	C5601104



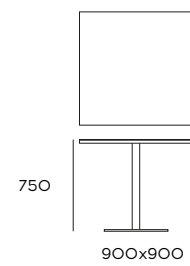

Tavolo quadrato con base quadrata
square table with square base, quadratischer Tisch mit quadratischer Grundfläche

COLORS	MATERIALS	CODE
nero, black, schwarz	metallo verniciato, painted metal, lackiertes Metall	C56Q0701
bianco, white, weiß	piano hpl, top hpl, tischplatte hpl	C56Q0702

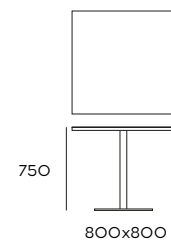

Tavolo quadrato con base quadrata
square table with square base, quadratischer Tisch mit quadratischer Grundfläche

COLORS	MATERIALS	CODE
nero, black, schwarz	metallo verniciato, painted metal, lackiertes Metall	C56Q1101
bianco, white, weiß	piano hpl, top hpl, tischplatte hpl	C56Q102

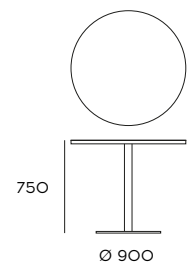

Tavolo tondo con base quadrata
round table with round base, rund Tisch mit quadratischer Grundfläche

COLORS	MATERIALS	CODE
nero, black, schwarz	metallo verniciato, painted metal, lackiertes Metall	C56Q0705
bianco, white, weiß	piano hpl, top hpl, tischplatte hpl	C56Q0706

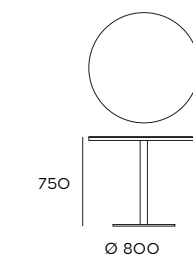

Tavolo tondo con base quadrata
round table with round base, rund Tisch mit quadratischer Grundfläche

COLORS	MATERIALS	CODE
nero, black, schwarz	metallo verniciato, painted metal, lackiertes Metall	C56Q1103
bianco, white, weiß	piano hpl, top hpl, tischplatte hpl	C56Q1104



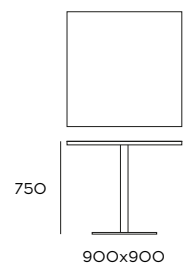

Tavolo con base tonda e vasca quadrata
square table with round base, quadratischer
Tisch mit runder Grundfläche

COLORS	MATERIALS	CODE
nero, black, schwarz	metallo verniciato, painted metal, lackiertes Metall	C56BV7VO1
bianco, white, weiß	piano hpl, top hpl tischplatte hpl	C56BV7VO2

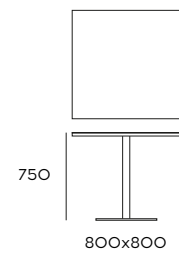

Tavolo con base tonda e vasca quadrata
square table with round base, quadratischer
Tisch mit runder Grundfläche

COLORS	MATERIALS	CODE
nero, black, schwarz	metallo verniciato, painted metal, lackiertes Metall	C56BV11VO1
bianco, white, weiß	piano hpl, top hpl tischplatte hpl	C56BV11VO2



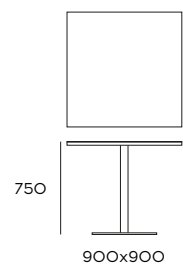

Tavolo con base quadrata e vasca quadrata
square table with square base, quadratischer
Tisch mit quadratischer Grundfläche

COLORS	MATERIALS	CODE
nero, black, schwarz	metallo verniciato, painted metal, lackiertes Metall	C56QBVO7VO1
bianco, white, weiß	piano hpl, top hpl tischplatte hpl	C56QBVO7VO2

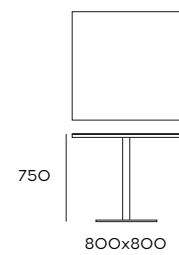

Tavolo con base quadrata e vasca quadrata
square table with square base, quadratischer
Tisch mit quadratischer Grundfläche

COLORS	MATERIALS	CODE
nero, black, schwarz	metallo verniciato, painted metal, lackiertes Metall	C56QBV11VO1
bianco, white, weiß	piano hpl, top hpl tischplatte hpl	C56QBV11VO2



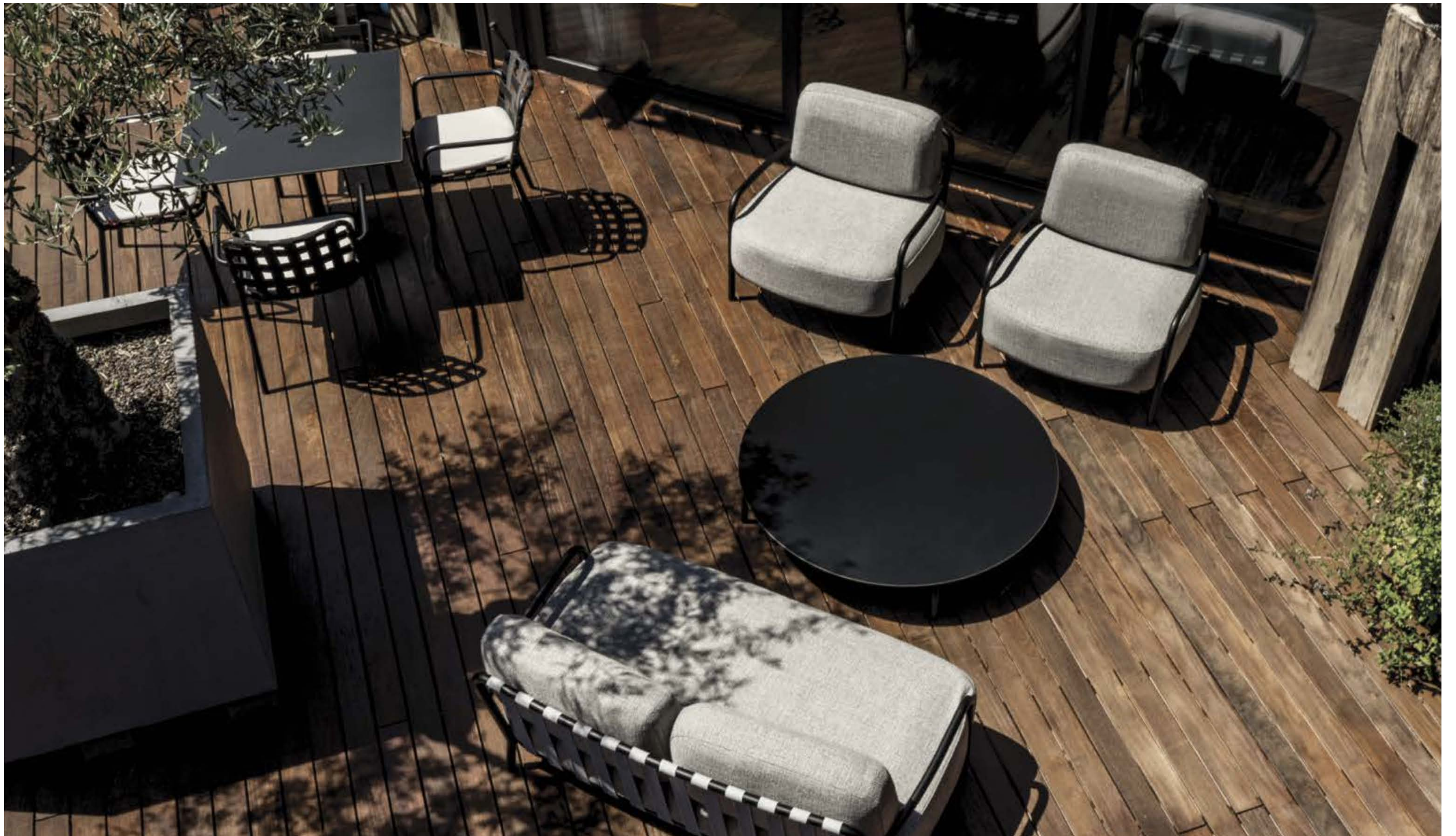

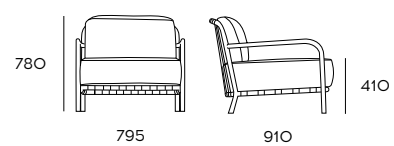

Poltrona
armchair, Sessel

COLORS	MATERIALS	CODE
nero, black, schwarz	metallo verniciato painted metal, lackiertes Metall	C5600101
bianco, white, weiß	polipropilene, polypropylene, Polypropylen	C5600102

Cuscini
pillow, Kissen

FABRIC	CODE
classe A	C56001CUA
classe B	C56001CUB
classe C	C56001CUC

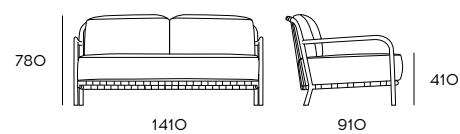

Divano
sofa, sofa

COLORS	MATERIALS	CODE
nero, black, schwarz	metallo verniciato painted metal, lackiertes Metall	C5600401
bianco, white, weiß	polipropilene, polypropylene, Polypropylen	C5600402

Cuscini
pillow, kissen

FABRIC	CODE
classe A	C56004CUA
classe B	C56004CUB
classe C	C56004CUC



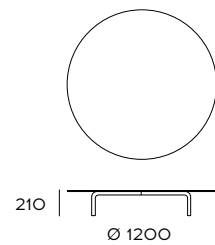

Tavolo basso tondo
round low table, rund niedrig Tisch

COLORS	MATERIALS	CODE
nero, black, schwarz	metallo verniciato, painted metal, lackiertes Metall	C5600601
bianco, white, weiß	piano hpl, top hpl tischplatte hpl	C5600602

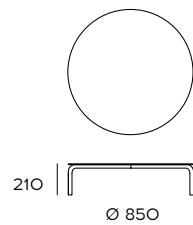

Tavolo basso tondo
round low table, rund niedrig Tisch

COLORS	MATERIALS	CODE
nero, black, schwarz	metallo verniciato, painted metal, lackiertes Metall	C5601501
bianco, white, weiß	piano hpl, top hpl tischplatte hpl	C5601502

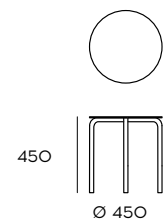

Tavolo basso tondo
round low table, rund niedrig Tisch

COLORS	MATERIALS	CODE
nero, black, schwarz	metallo verniciato, painted metal, lackiertes Metall	C5601701
bianco, white, weiß	piano hpl, top hpl tischplatte hpl	C5601702

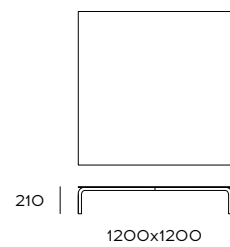

Tavolo basso quadrato
square low table, niedriger quadratischer Tisch

COLORS	MATERIALS	CODE
nero, black, schwarz	metallo verniciato, painted metal, lackiertes Metall	C5600501
bianco, white, weiß	piano hpl, top hpl tischplatte hpl	C5600502

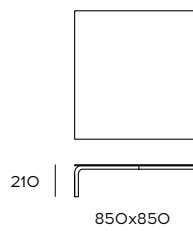

Tavolo basso quadrato
square low table, niedriger quadratischer Tisch

COLORS	MATERIALS	CODE
nero, black, schwarz	metallo verniciato, painted metal, lackiertes Metall	C5602201
bianco, white, weiß	piano hpl, top hpl tischplatte hpl	C5602202

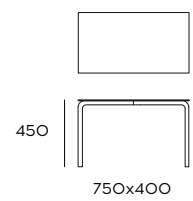

Tavolo basso rettangolare
rectangular low table, niedriger rechteckiger Tisch

COLORS	MATERIALS	CODE
nero, black, schwarz	metallo verniciato, painted metal, lackiertes Metall	C5601401
bianco, white, weiß	piano hpl, top hpl tischplatte hpl	C5601402



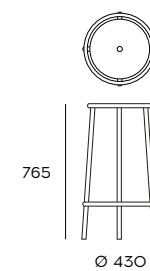
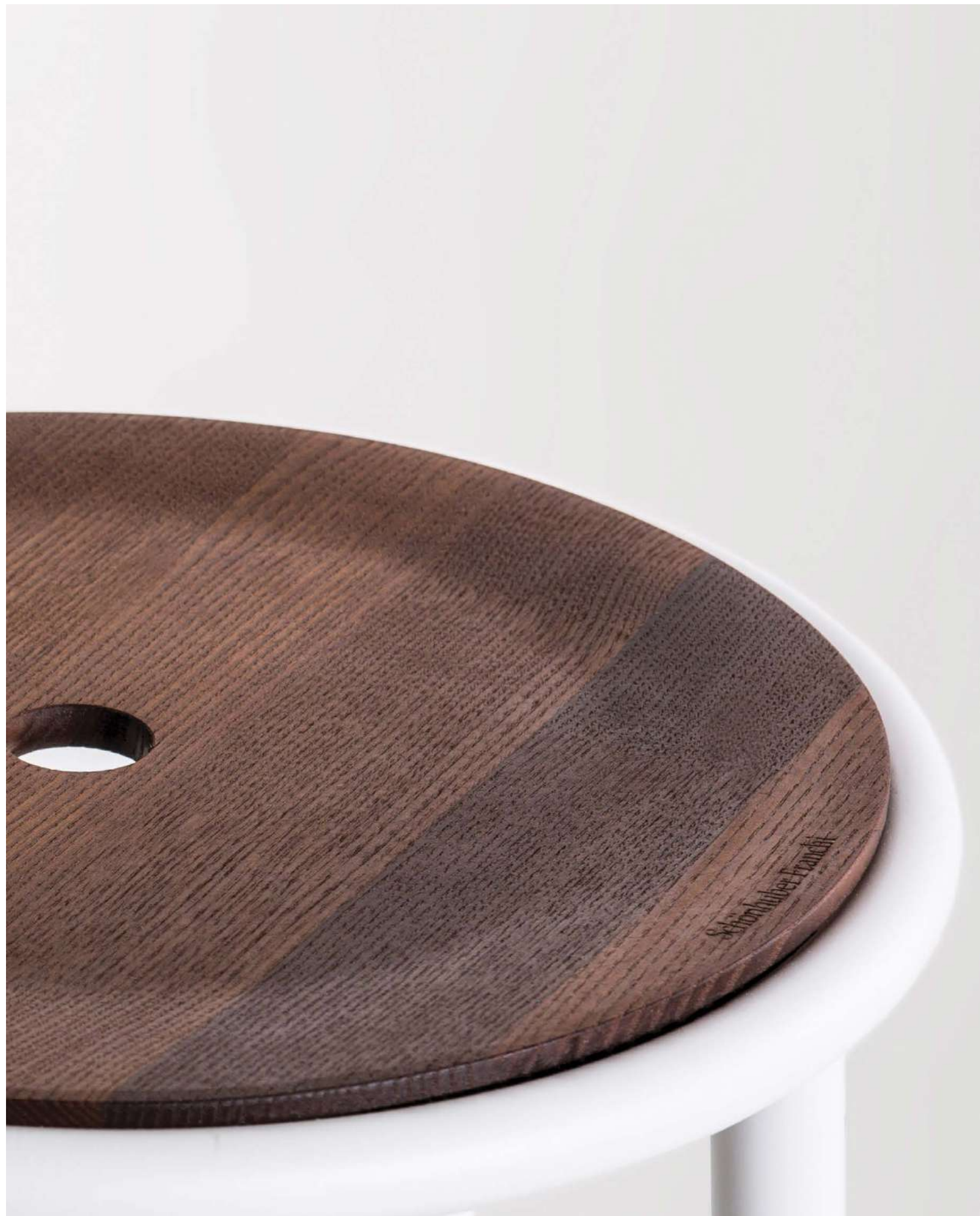

Sgabello
stool, barhocker

COLORS	MATERIALS	CODE
nero, black, schwarz	acciaio e frassino termotrattato, steel and heat-treated ash	C5601301
bianco, white, weiß	Stahl und wärmebehandelte Asche	C5601302

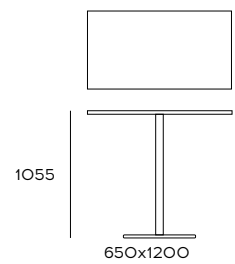

Tavolo alto rettangolare
high rectangular table, rechteckiger Hochtisch

COLORS	MATERIALS	CODE
nero, black, schwarz	metallo verniciato, painted metal, lackiertes Metall	C5601801
bianco, white, weiß	piano hpl, top hpl tischplatte hpl	C5601802

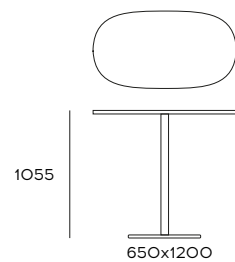

Tavolo alto ovale
high oval table, ovaler Hochtisch

COLORS	MATERIALS	CODE
nero, black, schwarz	metallo verniciato, painted metal, lackiertes Metall	C5600901
bianco, white, weiß	piano hpl, top hpl tischplatte hpl	C5600902

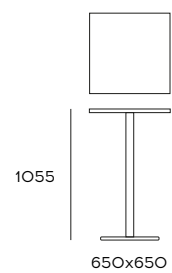

Tavolo alto quadrato
high square table, quadratischer Hochtisch

COLORS	MATERIALS	CODE
nero, black, schwarz	metallo verniciato, painted metal, lackiertes Metall	C5601901
bianco, white, weiß	piano hpl, top hpl tischplatte hpl	C5601902

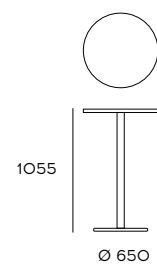

Tavolo alto tondo
high round table, runder Hochtisch

COLORS	MATERIALS	CODE
nero, black, schwarz	metallo verniciato, painted metal, lackiertes Metall	C5601001
bianco, white, weiß	piano hpl, top hpl tischplatte hpl	C5601002





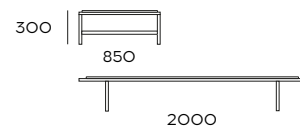

Letfino
sunlounger, sonnenliege

COLORS	MATERIALS	FABRIC	CODE
nero, black, schwarz	metallo verniciato con rivestimento in batyline, painted metal with batyline coating, lackiertes Metall mit Batyline-Beschichtung	classe A	C56O2003
		classe B	C56O2001
classe A		C56O2004	
classe B		C56O2002	

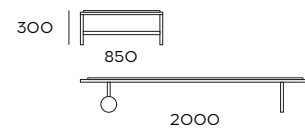

Letfino con ruote
sunlounger with tire, sonnenliege mit Rädern

COLORS	MATERIALS	FABRIC	CODE
nero, black, schwarz	metallo verniciato con rivestimento in batyline, painted metal with batyline coating, lackiertes Metall mit Batyline-Beschichtung	classe A	C56O2103
		classe B	C56O2101
classe A		C56O2104	
classe B		C56O2102	

Poggiatesta
headrest, Kopfstütze

SHAPE	CODE
tondo, round, Runde	C56O2A
rettangolare, rectangular rechteckig	C56O2B

T-soft

Design Lara Caffi

È in alluminio la struttura portante della collezione T-soft di Lara Caffi, composta da poltrone, divani a due e tre posti e lettini. La particolare lavorazione dell'alluminio, tagliato a laser e piegato, consente la realizzazione del pezzo da un'unica lastra, evitando saldature tra le parti. Generose imbottiture utilizzate per le sedute e gli schienali, rivestite con tessuti resistenti agli agenti atmosferici, regalano a Tsoft una linea morbida e di piacevole utilizzo.

Aluminium is the load bearing frame of the T-soft collection by Lara Caffi, comprising of armchair, two seater and three seater sofas and sun beds. The particular workmanship of the aluminium; laser cut and manipulation, allows the item to be realized from a single sheet, therefore avoiding welding of parts. Generous padded cushions used for the seat and back, covered with fabrics resistant to atmospheric agents; bring to T-Soft a soft line and pleasant use.

Die tragende Struktur der T-soft Kollektion von Lara Caffi ist aus Aluminium und besteht aus Sesseln, zwei- und dreisitzigen Sofas und Sonnenliegen. Die spezielle Bearbeitung von Aluminium, lasergeschnitten und gefaltet, ermöglicht die Konstruktion des Werkstücks aus einer einzigen Platte, wodurch ein Verschweißen der Komponenten vermieden wird. Großzügige Polsterungen für Sitze und Rückenlehnen, die mit atmosphärischen Stoffen bezogen sind, verleihen T-soft eine weiche und angenehme Anwendung.



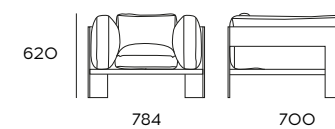

Poltrona
armchair, sessel

MATERIALS	CODE
iroko e metallo verniciato iroko and painted metal, iroko und lackiertes Metall	C57100100

Cuscini
pillow, kissen

FABRIC	CODE
classe A	C571001CUA
classe B	C571001CUB
classe C	C571001CUC

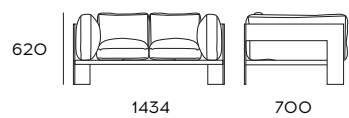

Divano 2 posti
sofa, 2-Sitzer-Sofa

MATERIALS	CODE
iroko e metallo verniciato, iroko and painted metal, iroko und lackiertes Metall	C57100200

Cuscini
pillow, kissen

FABRIC	CODE
classe A	C571002CUA
classe B	C571002CUB
classe C	C571002CUC

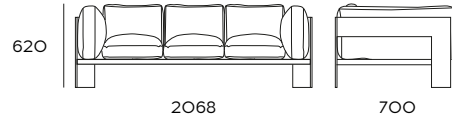

Divano 3 posti
sofa, 3-Sitzer-Sofa

MATERIALS	CODE
iroko e metallo verniciato, iroko and painted metal, iroko und lackiertes Metall	C57100300

Cuscini
pillow, kissen

FABRIC	CODE
classe A	C571003CUA
classe B	C571003CUB
classe C	C571003CUC





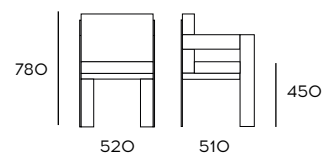
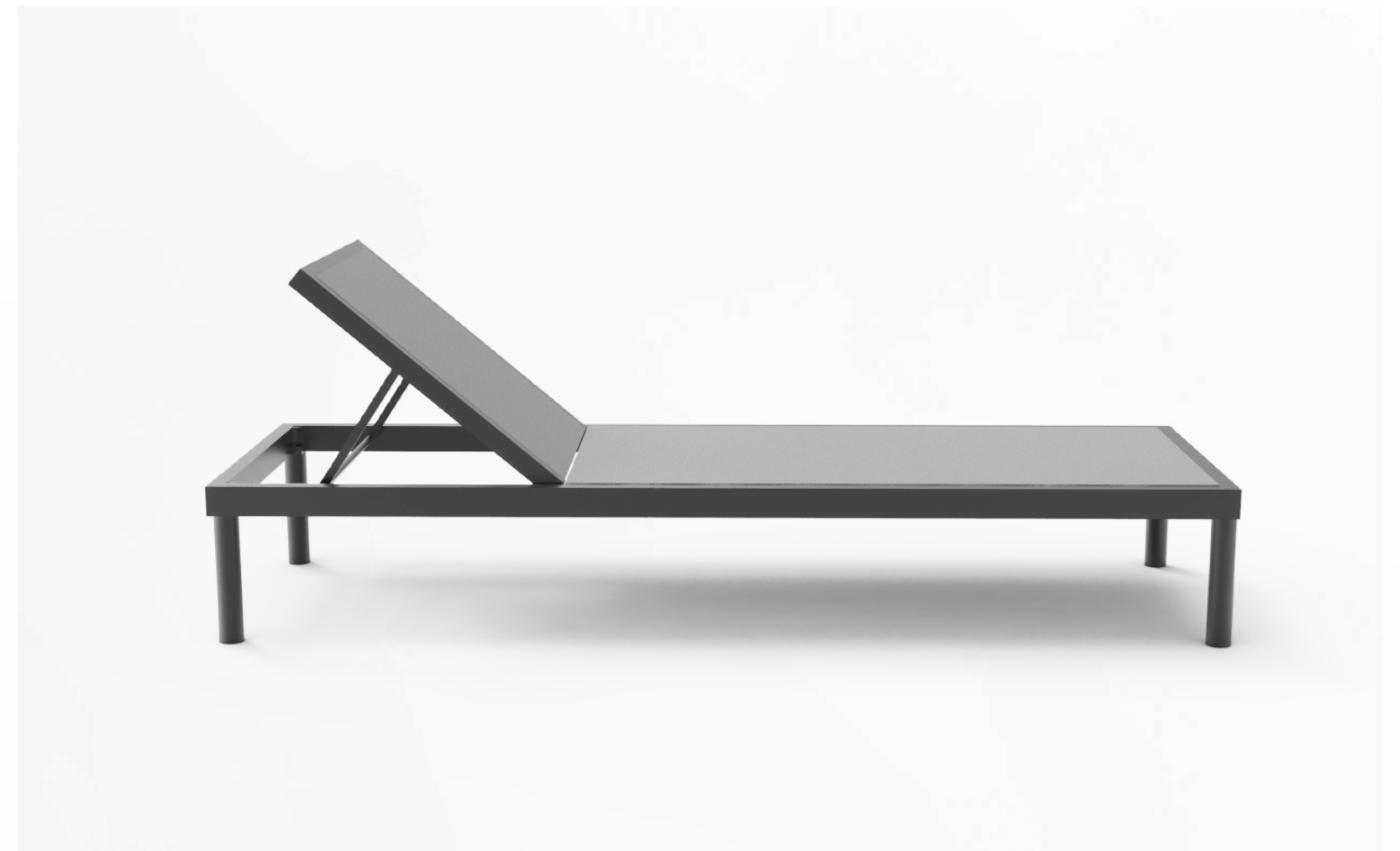

Poltroncina
small armchair, kleiner Armlehnstuhl

MATERIALS	CODE
iroko e metallo verniciato iroko and painted metal, iroko und lackiertes Metall	C5710O600

Cuscini
pillow, kissen

FABRIC	CODE
classe A	C5710O6CUA
classe B	C5710O6CUB
classe C	C5710O6CUC

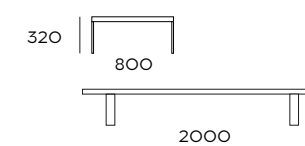

Letfino
sun lounger, sonnenliege

MATERIALS	COLORS/FINISHES	CODE
alluminio verniciato e batyline, painted aluminum and batyline, lackiertes Aluminium und Batyline	su richiesta on request auf Anfrage	C571AO701

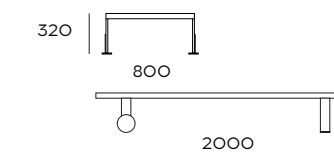

Letfino con ruote
sunlounger with tire, sonnenliege mit Rädern

MATERIALS	COLORS/FINISHES	CODE
alluminio verniciato e batyline, painted aluminum and batyline, lackiertes Aluminium und Batyline	su richiesta on request auf Anfrage	C571AO700

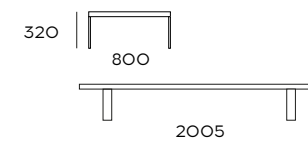
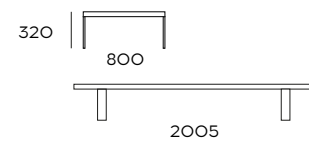
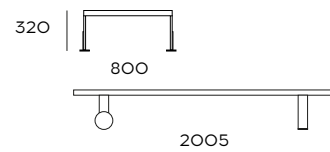

Lettino con ruote
sunlounger with tire, sonnenliege mit Rädern

COLORS	MATERIALS	CODE
iroko	iroko e metallo verniciato con rivestimento in batyline, iroko and painted metal with batyline coating, iroko und lackiertes mit Batyline-Beschichtung	C57100500

Lettino
sunlounger, Sonnenliege

COLORS	MATERIALS	CODE
iroko	iroko e metallo verniciato con rivestimento in batyline, iroko and painted metal with batyline coating, iroko und lackiertes mit Batyline-Beschichtung	C57100501

Lettino
sunlounger, Sonnenliege

COLORS	MATERIALS	CODE
iroko	iroko con rivestimento in batyline, iroko with batyline coating, iroko mit Batyline-Beschichtung	C57200501



Carla

Design Studio Brizzi-Riefenstahl

Si chiama Carla la sedia disegnata dallo studio Brizzi Riefenstahl pensata per arredare gli spazi comuni all'interno di strutture ricettive.

La struttura è in metallo e lo schienale può essere realizzato in legno di eucalipto o in alluminio verniciato.

La forma estremamente avvolgente, e l'imbottitura in tessuti ricercati la rendono una sedia particolarmente ricca ed elegante.

Carla is the name of the chair designed by Studio Brizzi Riefenstahl, idealized to furnish communal areas inside accommodation facilities. The frame is in metal and the back can be produced in eucalyptus or in varnished aluminium. The extremely embracing form and the padded cushion in refined fabric render it a chair particularly luxurious and elegant.

Carla ist der neue Stuhl aus der Feder des Ateliers Brizzi Riefenstahl entworfen wurde. Gedacht ist er für Gemeinschaftsbereiche in Hotels. Die Struktur besteht aus Metall und die Rückseite kann aus Eukalyptusholz oder lackiertem Aluminium bestehen. Die extrem einhüllende Form und die Polsterung aus edlen Stoffen, machen ihn zu einem besonders edlen und eleganten Stuhl.





Sedia con cuscino
chair, Stuhl

MATERIALS	FABRIC	CODE
metallo verniciato, painted metal, lackiertes Metall	CLASSE A	C62008CUA
	CLASSE B	C62008CUB
	CLASSE C	C62008CUC

Cuscino schienale
back pillow, Rückenkissen

FABRIC	CODE
CLASSE A	C62100CUA
CLASSE B	C62100CUB
CLASSE C	C62100CUC

Simple

Design Marcello Ziliani

Ridurre un divano a pochi elementi fondamentali: un telaio in tubolare d'acciaio, un nastro in tessuto, cuscini imbottiti. Da qui nasce Simple, sofisticata famiglia di poltrone, divani, sedie, pouf e tavolini in cui la sapiente fusione di materiali e finiture esalta la semplicità delle forme, la razionalità delle soluzioni, il comfort e la qualità costruttiva.

Reduce a sofa to just a few fundamental elements: a frame in tubular steel, a fabric strap and a padded cushion. This is the birth of Simple, a sophisticated family of armchairs, sofas, chairs and tables where the clever fusion of materials and finishes emphasise the simplicity of the forms, the sense of solutions, comfort and build quality.

Reduktion eines Sofas auf wenige Grundelemente: ein Stahlrohrgestell, ein Stoffband und Polsterkissen. So entstand Simple, eine raffinierte Familie von Sesseln, Sofas, Stühlen, Puffs und Couchtischen, bei der die gekonnte Verschmelzung von Materialien und Oberflächen die Einfachheit der Formen, die Rationalität der Lösungen, den Komfort und die Verarbeitungsqualität hervorhebt.



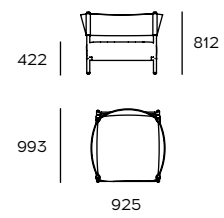

Poltrona
armchair, sessel

MATERIALS	COLORS/FINISHES	FABRIC	CODE
metallo verniciato painted metal, lackiertes Metall	su richiesta on request auf Anfrage	CLASSE A	C5500901A
cuscino in espanso rivestito in tessuto foam cushion with fabric cover Schaumstoff Kissen bezogen mit Stoff		CLASSE B	C5500901B
fasce in batyline, batyline straps Batyline-Bände		CLASSE C	C5500901C



Cuscino schienale
back pillow, Rückenkissen

FABRIC	CODE
CLASSE A	C55009SA
CLASSE B	C55009SB
CLASSE C	C55009SC

Cuscino bracciolo
cushion for armrest,
Armlehnenkissen

FABRIC	CODE
CLASSE A	C55009SBA
CLASSE B	C55009SBB
CLASSE C	C55009SBC

Cuscino volante
loose cushion, Kissen Volant

FABRIC	CODE
CLASSE A	C55009VA
CLASSE B	C55009SVB
CLASSE C	C55009SVC

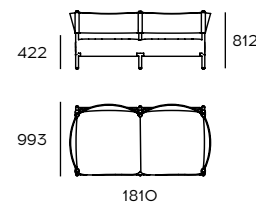

Divano 2 posti
sofa, 2-Sitzer-Sofal

MATERIALS	COLORS/FINISHES	FABRIC	CODE
metallo verniciato painted metal, lackiertes Metall	su richiesta on request auf Anfrage	CLASSE A	C5500801A
cuscino in espanso rivestito in tessuto foam cushion with fabric cover Schaumstoff Kissen bezogen mit Stoff		CLASSE B	C5500801B
fasce in batyline, batyline straps Batyline-Bände		CLASSE C	C5500801C

Cuscino schienale
back pillow, Rückenkissen

FABRIC	CODE
CLASSE A	C55009SA
CLASSE B	C55009SB
CLASSE C	C55009SC

Cuscino bracciolo
cushion for armrest,
Armlehnenkissen

FABRIC	CODE
CLASSE A	C55009SBA
CLASSE B	C55009SBB
CLASSE C	C55009SBC

Cuscino volante
loose cushion, Kissen Volant

FABRIC	CODE
CLASSE A	C55009VA
CLASSE B	C55009VB
CLASSE C	C55009VC

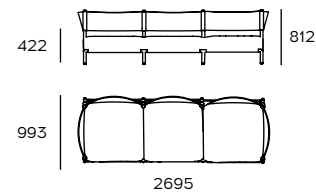

Divano 3 posti
sofa, 3-Sitzer-Sofa

MATERIALS	COLORS/FINISHES	FABRIC	CODE
metallo verniciato painted metal, lackiertes Metall	su richiesta on request auf Anfrage	CLASSE A	C5500802A
cuscino in espanso rivestito in tessuto foam cushion with fabric cover Schaumstoff Kissen bezogen mit Stoff		CLASSE B	C5500802B
fasce in batyline, batyline straps Batyline-Bände		CLASSE C	C5500802C

Cuscino schienale
back pillow, Rückenkissen

FABRIC	CODE
CLASSE A	C550095A
CLASSE B	C550095B
CLASSE C	C550095C

Cuscino bracciolo
cushion for armrest,
Armlehnenkissen

FABRIC	CODE
CLASSE A	C550095BA
CLASSE B	C550095BB
CLASSE C	C550095BC

Cuscino volante
loose cushion, Kissen Volant

FABRIC	CODE
CLASSE A	C550095VA
CLASSE B	C550095VB
CLASSE C	C550095VC



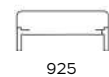

Pouff
pouff

MATERIALS	COLORS/FINISHES	CODE
metallo verniciato painted metal, lackiertes Metall cuscino in espanso rivestito in tessuto foam cushion with fabric cover Schaumstoff Kissen bezogen mit Stoff	su richiesta on request auf Anfrage	C55062

Cuscino
pillow, kissen

FABRIC	CODE
CLASSE A	C55062A
CLASSE B	C55062B
CLASSE C	C55062C

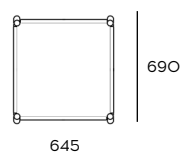
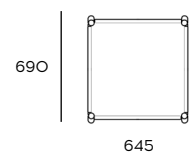

Tavolo basso quadrato
square low table, niedriger quadratischer Tisch

MATERIALS	COLORS/FINISHES	CODE
metallo verniciato painted metal, lackiertes Metall vassoio in alluminio, aluminum tray, Aluminium	su richiesta on request auf Anfrage	C55022

Tavolo basso quadrato
square low table, niedriger quadratischer Tisch

MATERIALS	COLORS/FINISHES	CODE
metallo verniciato painted metal, lackiertes Metall vassoio in alluminio, aluminum tray, Aluminium	su richiesta on request auf Anfrage	C55023

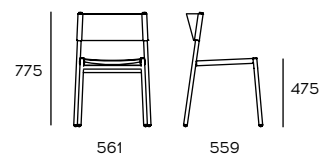

Sedia
chair, stuhl

MATERIALS	COLORS/FINISHES	CODE
metallo verniciato e batyline, painted metal and batyline lackiertes Metall und Batyline	su richiesta on request auf Anfrage	C55002



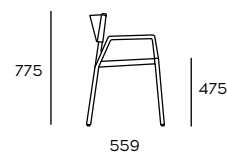

Sedia con braccioli
 chair with arms, stuhl mit Armlehnen

MATERIALS	COLORS/FINISHES	CODE
alluminio verniciato e batyline, painted aluminum and batyline, lackiertes Aluminium und Batyline	su richiesta, on request, auf Anfrage	C55003
	alluminio verniciato bianco, painted aluminum white, weiß lackiertes Aluminium	C5500302
	batyline bianco, white batyline, weiß Batyline	
	alluminio verniciato testa di moro, brown painted aluminum, Braun lackiertes Aluminium	C5500303
	batyline beige, beige batyline, Beige Batyline	

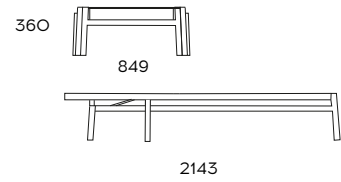

Lettino
sun lounger, sonnenliege

MATERIALS	COLORS/FINISHES	CODE
alluminio verniciato e batyline, painted aluminum and batyline, lackiertes Aluminium und Batyline	su richiesta, on request, auf Anfrage	C55O20
	alluminio verniciato bianco, painted aluminum white, weiß lackiertes Aluminium	C55O202
	batyline bianco, white batyline, weiß Batyline	
	alluminio verniciato testa di moro, brown painted aluminum, Braun lackiertes Aluminium	C55O203
batyline beige, beige batyline, Beige Batyline		

Sunset

Design Lorenzo Bellini

Candore, freschezza, brio e finezza.
Atmosfere delicate ricreate da forme e linee sinuosamente disegnate dal colore bianco o grigio: l'armonia espressa attraverso la leggerezza e la raffinatezza.

Candour, freshness, character and elegance. Delicate atmospheres recreated by forms and lines sinuously designed in white or anthracite gray: harmony expressed through lightness and stylishness.

Klarheit, Frische, Spritzigkeit und Finesse:
Sinnliche Formen und Linien in Weiß oder Grau versprühen Harmonie durch Leichtigkeit und Raffinesse.



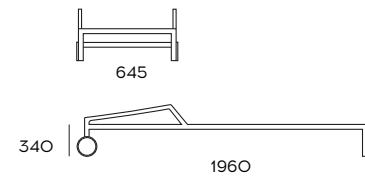
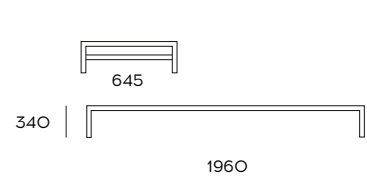

Letfino senza braccioli
sunlounger without armrests, Sonnenliege ohne Armlehnen

COLORS	MATERIALS	CODE
grigio, gray, grau	alluminio e batyline, aluminum and batyline, aluminium und batyline	C96000015
bianco, white, weiß		C96000013

Letfino con braccioli
sunlounger with armrests, Sonnenliege mit Armlehnen

COLORS	MATERIALS	CODE
grigio, gray, grau	alluminio e batyline, aluminum and batyline, aluminium und batyline	C96000008
bianco, white, weiß		C96000007

Easy Table

I prodotti più semplici sono quelli che mantengono la loro bellezza e originalità nel tempo.

Easy tables è una collezione di tavoli dalle linee pulite e lineari.

Le svariate finiture disponibili rendono la collezione versatile con infinite possibilità di abbinamento.

The most simple products are those that maintain their beauty and originality over time. Easy tables are a collection of tables with clean and consistent contours.

The varied finishes available make this a versatile collection with never ending possibilities of combinations

Die einfachsten Produkte sind diejenigen, die im Laufe der Zeit ihre Schönheit und Originalität bewahren.

Easy tables ist eine Kollektion von Tischen mit klaren, linearen Linien.

Die verschiedenen Oberflächen machen die Kollektion vielseitig und bieten endlose Kombinationsmöglichkeiten.



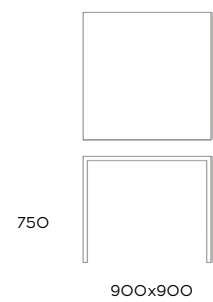

Tavolo quadrato
square table, quadratischer Tisch

MATERIALS	CODE
bianco con piano in hpl bianco White with tabletop in white hpl weiß mit weißer Hpl-Platte	C53007021202
nero con piano in gres laminam nero effetto marmo black with tabletop in gres with a black marble effect laminate schwarz mit schwarzer Laminam-Steinzeugplatte in Marmoroptik	C53007011201
marrone testa di moro con piano in iroko Chestnut brown with tabletop in iroko dunkelbraun mit Iroko-Platte	C530070613

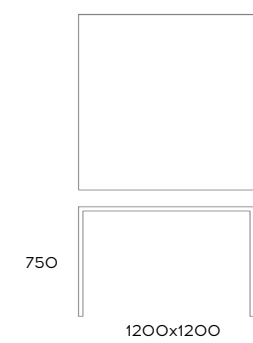

Tavolo quadrato
square table, quadratischer Tisch

MATERIALS	CODE
bianco con piano in hpl bianco White with tabletop in white hpl weiß mit weißer Hpl-Platte	C53028021202
nero con piano in gres laminam nero effetto marmo black with tabletop in gres with a black marble effect laminate schwarz mit schwarzer Laminam-Steinzeugplatte in Marmoroptik	C53028011201
marrone testa di moro con piano in iroko Chestnut brown with tabletop in iroko dunkelbraun mit Iroko-Platte	C530280613

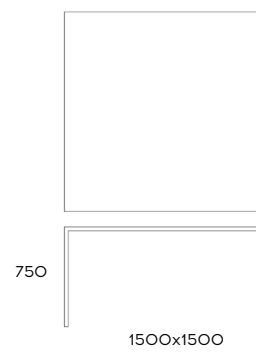

Tavolo quadrato
square table, quadratischer Tisch

MATERIALS	CODE
bianco con piano in hpl bianco White with tabletop in white hpl weiß mit weißer Hpl-Platte	C53029021202
nero con piano in gres laminam nero effetto marmo black with tabletop in gres with a black marble effect laminate schwarz mit schwarzer Laminam-Steinzeugplatte in Marmoroptik	C53029011201
marrone testa di moro con piano in iroko Chestnut brown with tabletop in iroko dunkelbraun mit Iroko-Platte	C530290613

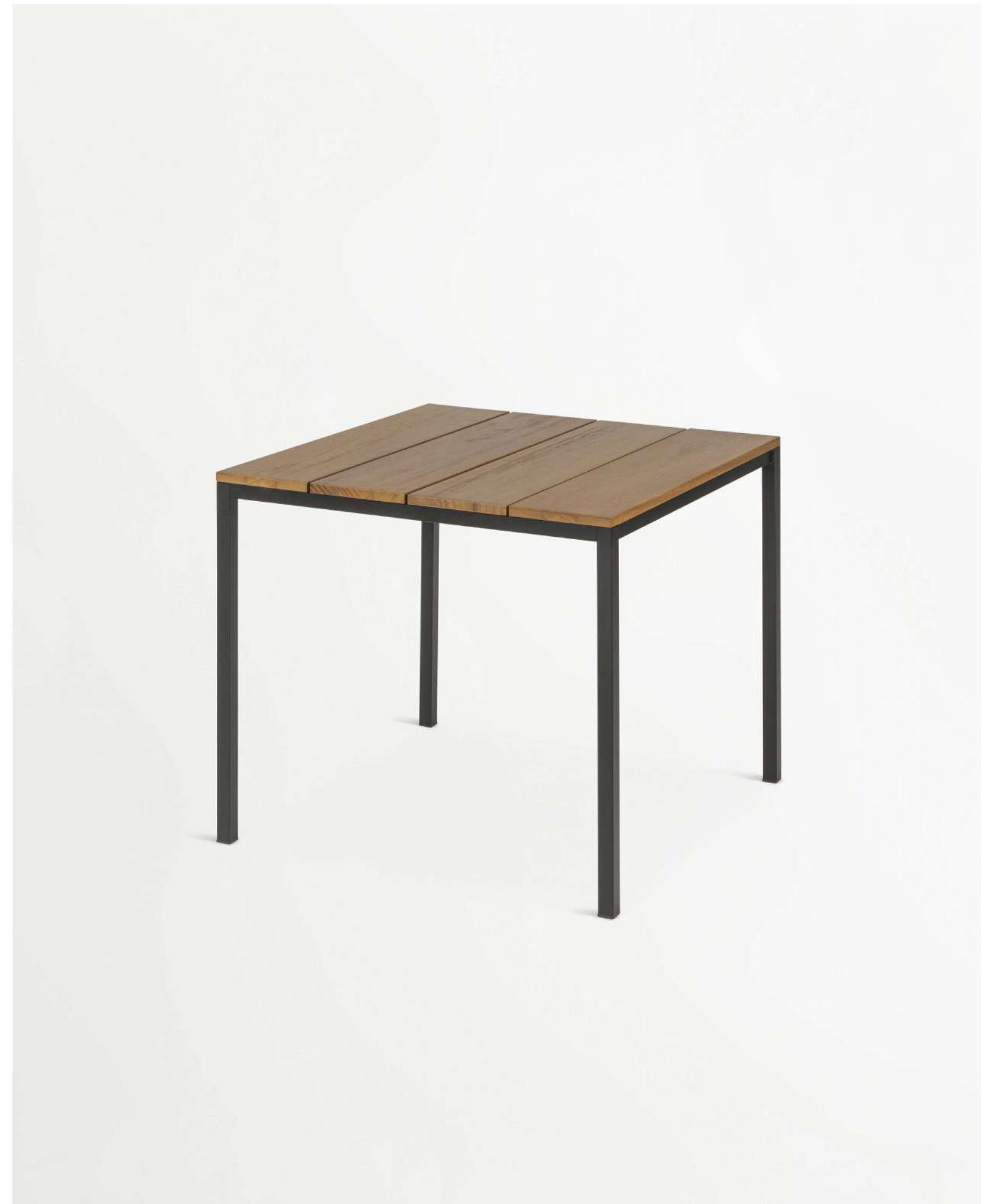



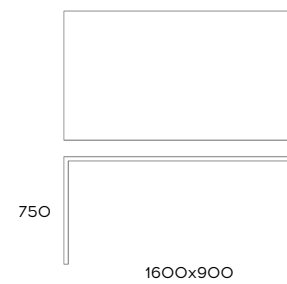

Tavolo rettangolare
rectangular table, rechteckiger Tisch

MATERIALS	CODE
bianco con piano in hpl bianco White with tabletop in white hpl weiß mit weißer Hpl-Platte	C53030021202
nero con piano in gres laminam nero effetto marmo black with tabletop in gres with a black marble effect laminate schwarz mit schwarzer Laminam-Steinzeugplatte in Marmoroptik	C53030011201
marrone testa di moro con piano in iroko Chestnut brown with tabletop in iroko dunkelbraun mit Iroko-Platte	C530300613

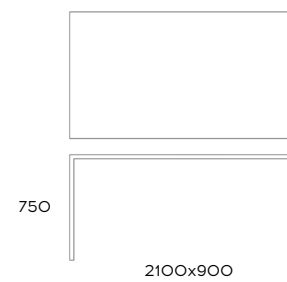

Tavolo quadrato
square table, quadratischer Tisch

MATERIALS	CODE
bianco con piano in hpl bianco White with tabletop in white hpl weiß mit weißer Hpl-Platte	C53031021202
nero con piano in gres laminam nero effetto marmo black with tabletop in gres with a black marble effect laminate schwarz mit schwarzer Laminam-Steinzeugplatte in Marmoroptik	C53031011201
marrone testa di moro con piano in iroko Chestnut brown with tabletop in iroko dunkelbraun mit Iroko-Platte	C530310613

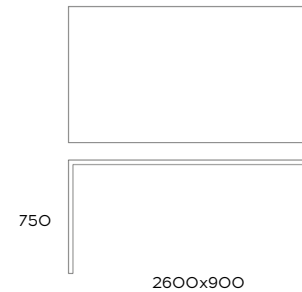

Tavolo rettangolare
rectangular table, rechteckiger Tisch

MATERIALS	CODE
bianco con piano in hpl bianco White with tabletop in white hpl weiß mit weißer Hpl-Platte	C53032021202
nero con piano in gres laminam nero effetto marmo black with tabletop in gres with a black marble effect laminate schwarz mit schwarzer Laminam-Steinzeugplatte in Marmoroptik	C53032011201
marrone testa di moro con piano in iroko Chestnut brown with tabletop in iroko dunkelbraun mit Iroko-Platte	C530320613



Pure

Design Marcello Ziliani

C'è molto carattere in Pure, così essenziale, ed elegante, la linea della gamba anteriore che si apre verso l'esterno e si curva all'indietro per salire a creare il sofisticato e confortevole schienale avvolgente. Il legno di Iroko, dai bellissimi riflessi ambrati, è destinato alle versioni outdoor, con seduta in fettuccia di corda nautica, prodotta e intrecciata a mano in Italia, o in batiline effetto tessuto. Declinata nelle versioni poltroncina da tavolo e poltrona lounge (entrambe impilabili) questa collezione è perfetta per una destinazione prettamente contract così come per arredare con raffinatezza ville e giardini privati.

The new product line Pure has an essential and elegant character. The line of the front leg is open to the outside and curved backwards to create the comfortable enveloping backrest. Iroko wood, with its beautiful, amber reflections, is designed for outdoor versions - with a nautical line, made and handcrafted in Italy, or fabric-effect batiline. Transferred to armchairs and lounge chairs (both stackable), this collection is great for stylishly setting up studios, villas, and private gardens.

Die neue Produktlinie Pure hat einen essentiellen und eleganten Charakter. Die Linie des Vorderbeins ist nach außen hin geöffnet und nach hinten gekrümmt, um die komfortabel umhüllende Rückenlehne zu schaffen. Iroko-Holz mit seinen schönen, bernsteinfarbenen Reflexen ist für Outdoor-Versionen vorgesehen - mit Sitz in nautischer Schnur, hergestellt und handgefertigt in Italien, oder in Batiline mit Stoffeffekt. Übertragen auf Sessel und Lounge-Sessel (beide stapelbar), eignet sich diese Kollektion hervorragend für das stilvolle Einrichten von Studios, Villen und privaten Gärten.

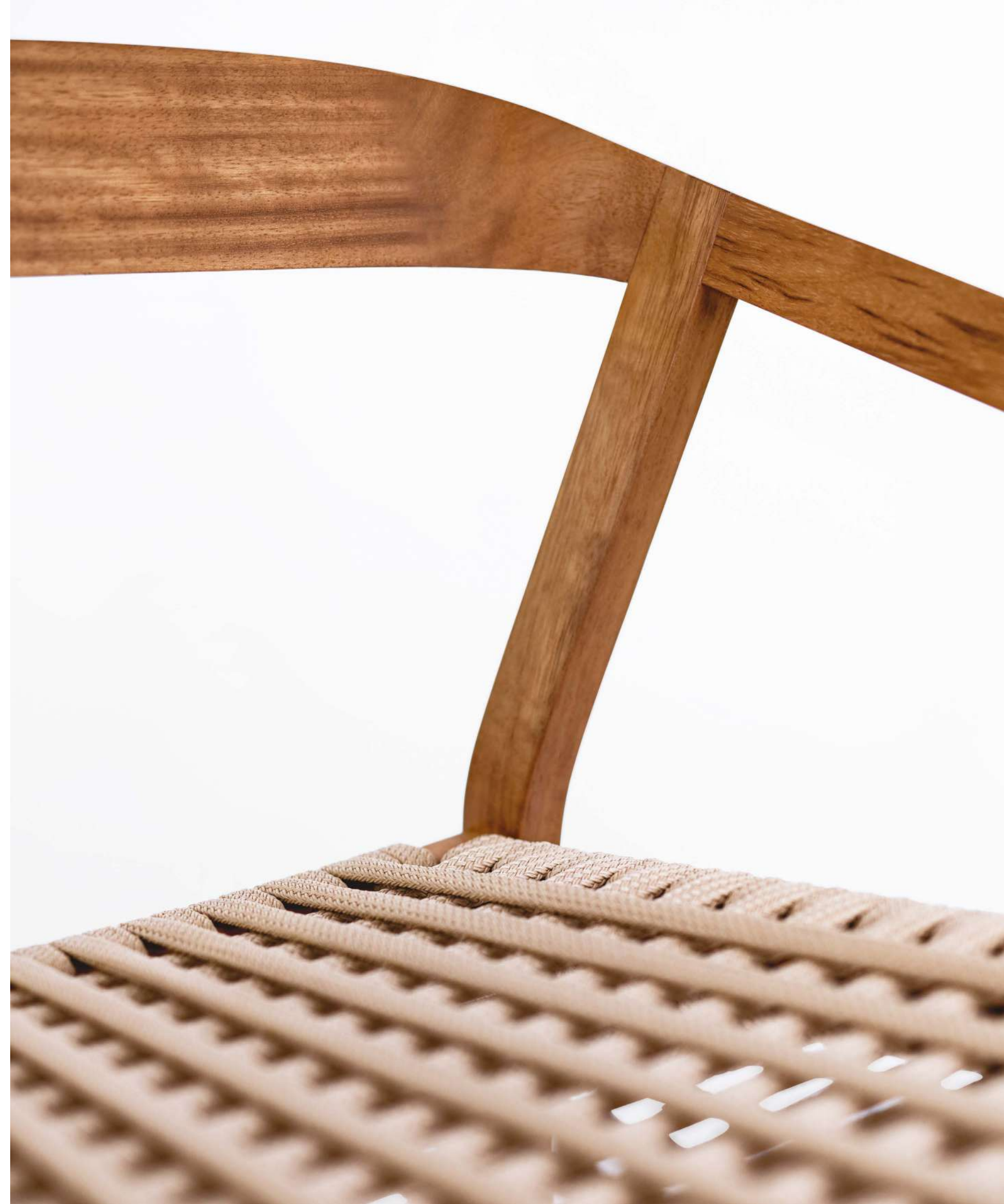

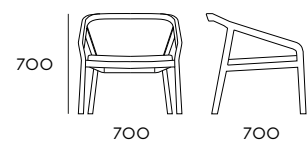

Poltrona XL
XL armchair, XL Armlehnstuhl

MATERIALS	CODE
iroko e corda, iroko and string, Iroko mit Schnür	C61X0002
iroko e batiline, iroko and batiline, Iroko und Batiline	C61X0003

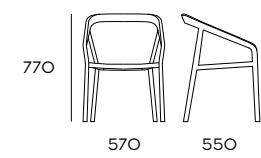

Poltroncina
small armchair, kleiner Armlehnstuhl

MATERIALS	CODE
iroko e corda, iroko and string, iroko mit Schnür	C610002
iroko e batiline, iroko and batiline, iroko und Batiline	C610003

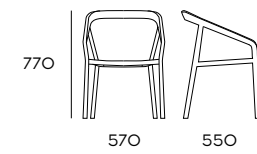

Poltroncina
small armchair, kleiner Armlehnstuhl

MATERIALS	COLORS/FINISHES	CODE
alluminio verniciato e batyline, painted aluminum and batyline, lackiertes Aluminium und Batyline	su richiesta, on request, auf Anfrage	C561A003
	alluminio verniciato bianco, painted aluminum white, weiß lackiertes Aluminium	C561A00302
	batyline bianco, white batyline, weiß Batyline	
	alluminio verniciato testa di moro, brown painted aluminum, Braun lackiertes Aluminium	C561A00303
batyline beige, beige batyline, Beige Batyline		

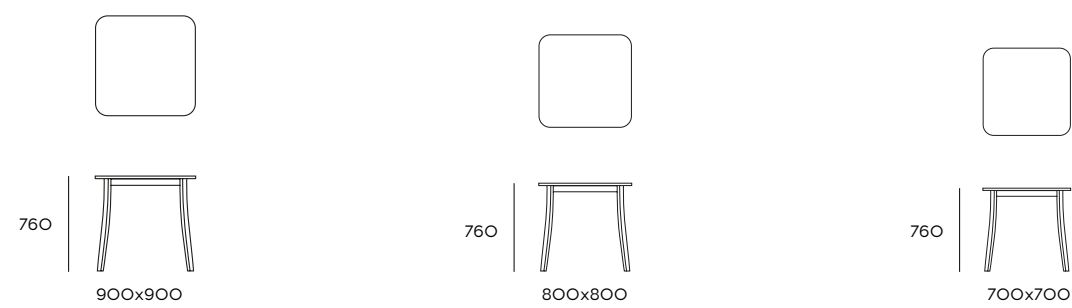

Tavolo
table, tisch

MATERIALS	CODE
legno iroko, iroko wood, Iroko-Holz	C6110013L09

Tavolo
table, tisch

MATERIALS	CODE
legno iroko, iroko wood, Iroko-Holz	C6120013L09

Tavolo
table, tisch

MATERIALS	CODE
legno iroko, iroko wood, Iroko-Holz	C6100013L09

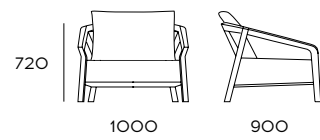

Poltrona
armchair, sessel

MATERIALS	FABRIC	CODE
legno iroko, iroko wood, Iroko-Holz	CLASSE C	C61100100

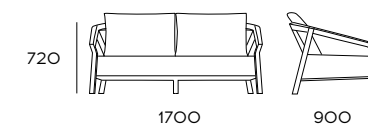

Divano 2 posti
sofa, 2-Sitzer-Sofa

MATERIALS	FABRIC	CODE
legno iroko, iroko wood, Iroko-Holz	CLASSE C	C61100200

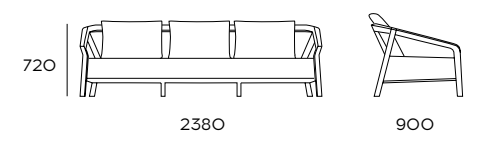

Divano 3 posti
sofa, 3-Sitzer-Sofa

MATERIALS	FABRIC	CODE
legno iroko, iroko wood, Iroko-Holz	CLASSE C	C61100300

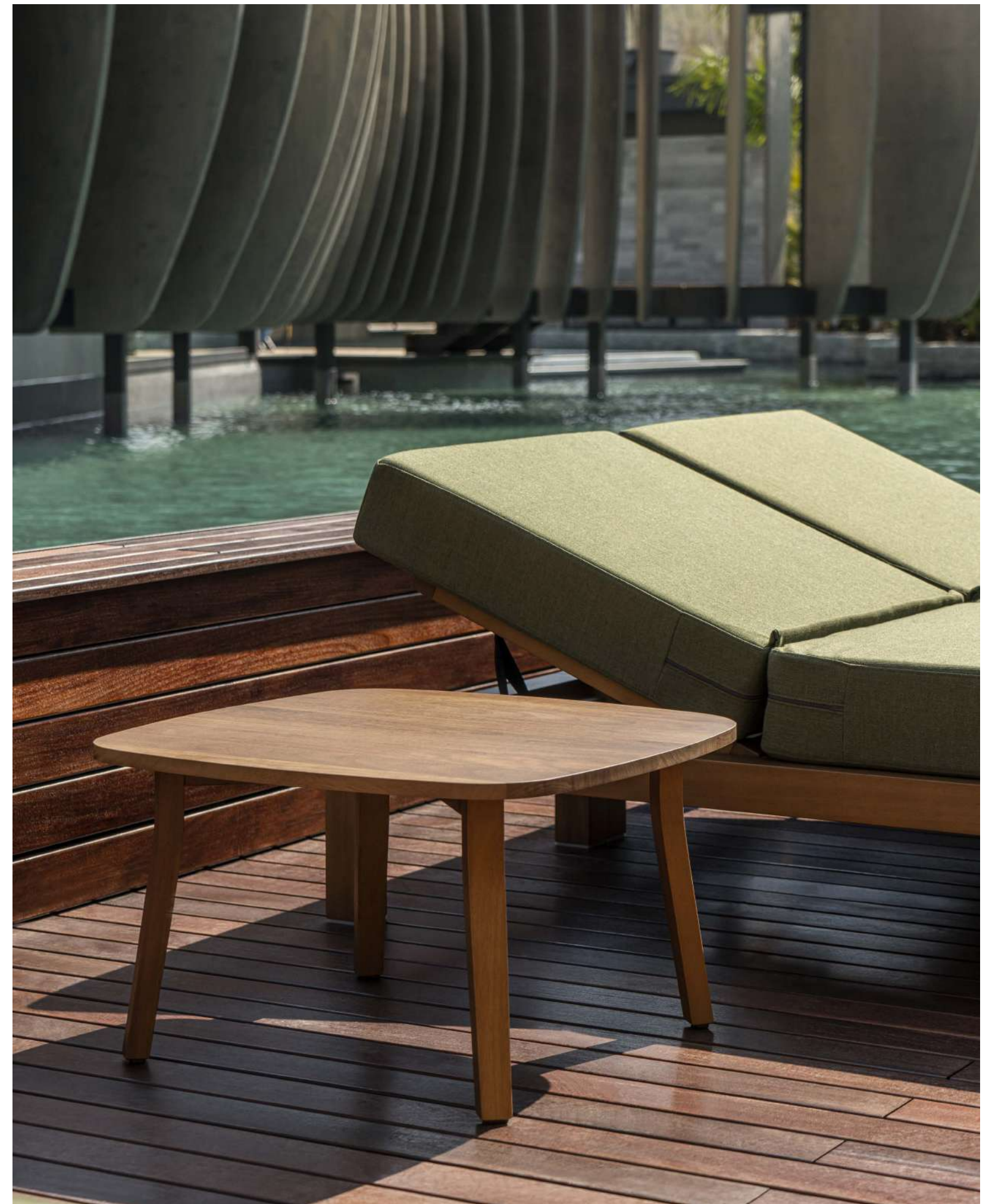

400

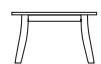

700x700

Tavolino basso
side table, beistelltisch

MATERIALS	CODE
legno iroko, iroko wood, Iroko-Holz	C6130013L09

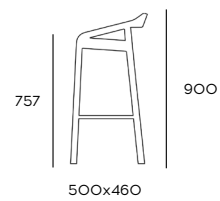

Sgabello
stool, barhocker

MATERIALS	COLORS/FINISHES	FABRIC	CODE
iroko e pelle o tessuto, iroko and leather or fabric, Iroko und Leder oder Stoff	su richiesta on request auf Anfrage	CLASSE A	C61O69CUA
		CLASSE B	C61O69CUB
		CLASSE C	C61O69CUC

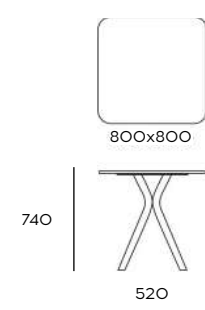
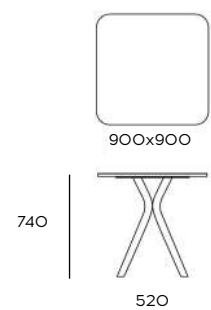

Tavolo quadrato a gambe centrali
square table, quadratischer Tisch

MATERIALS	COLORS/FINISHES	TOP	CODE
metallo verniciato, painted metal, lackiertes Metall	su richiesta on request auf Anfrage	iroko	C61063Q90I

Tavolo quadrato a gambe centrali
square table, quadratischer Tisch

MATERIALS	COLORS/FINISHES	TOP	CODE
metallo verniciato, painted metal, lackiertes Metall	su richiesta on request auf Anfrage	iroko	C61063Q80I

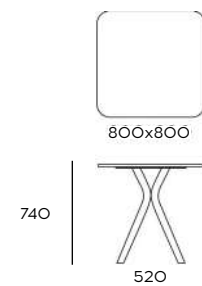
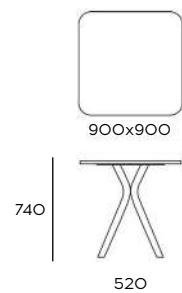

Tavolo quadrato a gambe centrali
square table, quadratischer Tisch

MATERIALS	COLORS/FINISHES	TOP	CODE
metallo verniciato, painted metal, lackiertes Metall	su richiesta on request auf Anfrage	frassino	C61O63Q9OF
		hpl	C61O63Q9OH
		gres	C61O63Q9OG

Tavolo quadrato a gambe centrali
square table, quadratischer Tisch

MATERIALS	COLORS/FINISHES	TOP	CODE
metallo verniciato, painted metal, lackiertes Metall	su richiesta on request auf Anfrage	frassino	C61O63Q8OF
		hpl	C61O63Q8OH
		gres	C61O63Q8OG

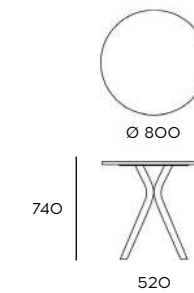
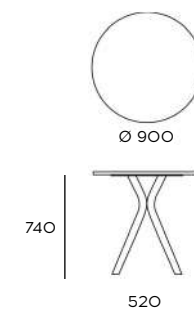

Tavolo tondo a gambe centrali
round table, rund Tisch

MATERIALS	COLORS/FINISHES	TOP	CODE
metallo verniciato, painted metal, lackiertes Metall	su richiesta on request auf Anfrage	frassino	C61O63D9OF
		hpl	C61O63D9OH
		gres	C61O63D9OG

Tavolo tondo a gambe centrali
round table, rund Tisch

MATERIALS	COLORS/FINISHES	TOP	CODE
metallo verniciato, painted metal, lackiertes Metall	su richiesta on request auf Anfrage	frassino	C61O63D8OF
		hpl	C61O63D8OH
		gres	C61O63D8OG



Java

Design Lorenzo Bellini

La Collezione Java è la nuova collezione outdoor progettata dall'Arch. Lorenzo Bellini. Una collezione estremamente ricca negli elementi che nasce dalla volontà di portare all'esterno i canoni estetici tradizionali delle collezioni indoor.

Di grande impatto la componente tessile che ne è l'elemento caratterizzante: cuscini abbondanti, materassi di grandi dimensioni per i lettini e nuovi tessuti (tra cui un elegantissimo velluto da esterno): comodità, eleganza rendono la collezione adattabile a qualsiasi ambiente.

The Java Collection is the new outdoor collection designed by Arch. Lorenzo Bellini. A collection extremely luxurious in the elements which are born from the desire to bring to the outdoors, the traditional standard of beauty of indoor collections. The strong effect of the fabric component is the characterising element: generous cushions, mattresses of large dimensions for the sun beds and new fabrics (amongst which is elegant velvet for outdoors): comfort and elegance render the collection suitable for any kind of surroundings.

Die neue Java Outdoor-Kollektion von Arch. Lorenzo Bellini. Eine äußerst reichhaltige Kollektion mit Elementen, die aus dem Wunsch hervorgeht, die traditionellen ästhetischen Kanons der Indoor-Kollektionen hervorzuheben. Das textile Element ist das auffälligste Merkmal: reichlich Kissen, großzügige Matratzen für Sonnenliegen und neue Stoffe (darunter ein eleganter Outdoor Samt Stoffe): Komfort und Eleganz machen die Kollektion an jede Umgebung anpassbar.



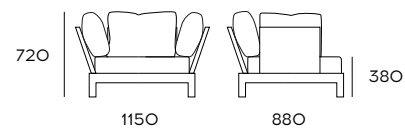

Poltrona
armchair, sessel

MATERIALS	CODE
legno iroko, iroko wood, Iroko-Holz	C50711601

Cuscini
pillow, kissen

FABRIC	CODE
classe A	C50711CUA
classe B	C50711CUB
classe C	C50711CUC



Divano 2 posti
sofa, 2-Sitzer-Sofa

MATERIALS	CODE
legno iroko, iroko wood, Iroko-Holz	C50718601

Cuscini
pillow, kissen

FABRIC	CODE
classe A	C50718CUA
classe B	C50718CUB
classe C	C50718CUC

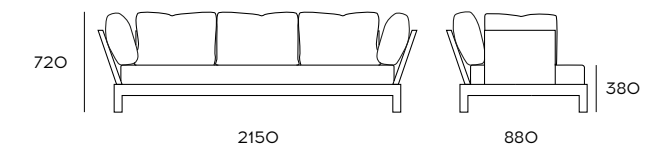

Divano 3 posti
sofa, 3-Sitzer-Sofa

MATERIALS	CODE
legno iroko, iroko wood, Iroko-Holz	C50710601

Cuscini
pillow, kissen

FABRIC	CODE
classe A	C50710CUA
classe B	C50710CUB
classe C	C50710CUC

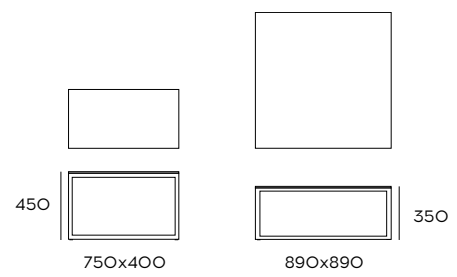

Tavolo basso
low table, niedriger Tisch

MATERIALS	CODE
alluminio e piano HPL, aluminum and HPL, lackiertes Metall und HPL	C5O7117O1
	C5O71O711



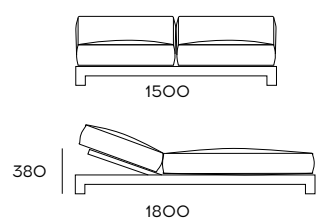
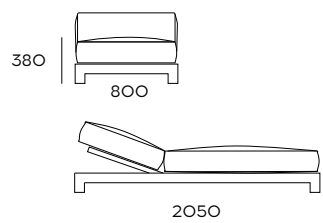

Letfino singolo Java
sunlounger, sonnenliege (1 Person)

MATERIALS	CODE
legno iroko, iroko wood, Iroko-Holz	C50715601

Cuscini
pillow, kissen

FABRIC	CODE
classe A	C50715CUA
classe B	C50715CUB
classe C	C50715CUC

Letfino doppio Java
sunlounger, Sonnenliege (2 Personen)

MATERIALS	CODE
legno iroko, iroko wood, Iroko-Holz	C50715501

Cuscini
pillow, kissen

FABRIC	CODE
classe A	C50716CUA
classe B	C50716CUB
classe C	C50716CUC

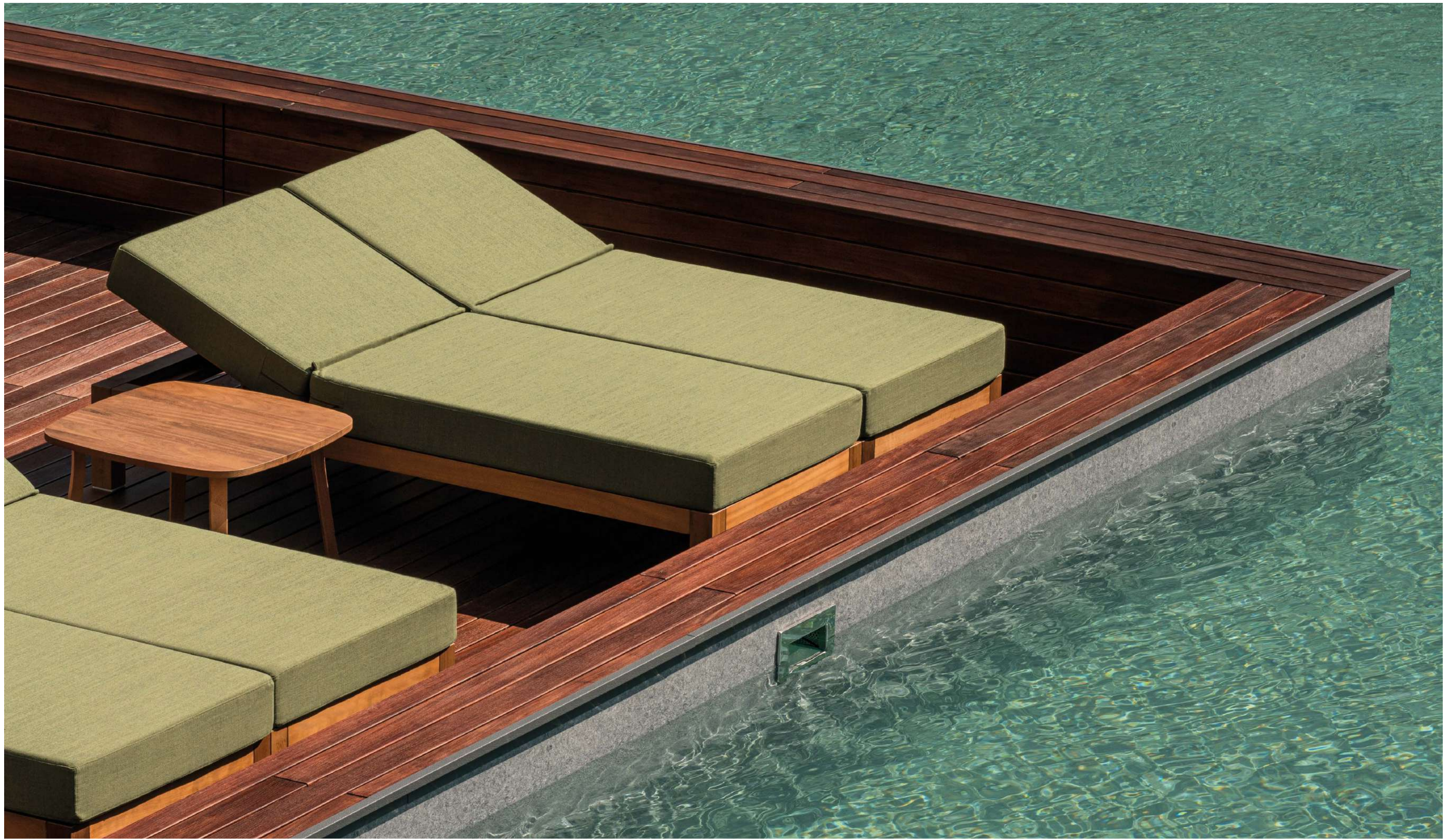

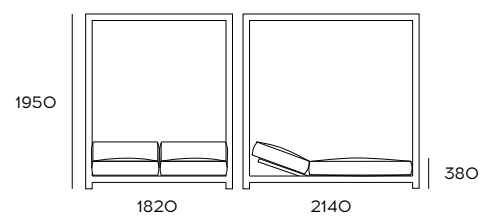

Baldacchino
canopy, Baldachin

MATERIALS	CODE
legno iroko, iroko wood, Iroko-Holz	C5O7166O1
tendaggio, curtain Vorhänge	C5O717TEN

Cuscini
pillow, kissen

FABRIC	CODE
classe A	C5O716CUA
classe B	C5O716CUB
classe C	C5O716CUC



Briccola

Design Marcello Ziliani

Le file irregolari di pali in legno che spuntano dall'acqua di Canal Grande sono l'immagine che ha ispirato questa collezione di imbottiti in cui lo schienale è creato da un ventaglio di "briccole" legate da fasce di tessuto mentre seduta e cuscini hanno le forme lisce e arrotondate dei ciottoli levigati dalle spiagge della laguna.

The irregular line of wooden poles that rise up from the waters of the Grand Canal is the image that inspired this collection of upholstered items where the back is created by a fan of "briccole" bound with strips of fabric whilst the seat and cushions have the smooth and rounded shapes of pebbles polished by the beaches of the lagoon.

Die unregelmäßigen Reihen von Holzpfählen, die aus dem Wasser des Canal Grande herausragen, sind das Bild, das diese Polstermöbelkollektion inspiriert hat. Die Rückenlehne besteht aus einem Fächer aus "Dalben", der mit Stoffbändern zusammengehalten wird, während die Sitzfläche und die Kissen die glatten, abgerundeten Formen von Kieselsteinen haben, die an den Stränden der Lagune geschliffen wurden.



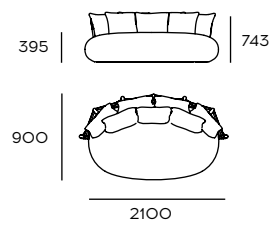

Divano 3 posti
sofa, 3-Sitzer-Sofa

MATERIALS	COLORS/FINISHES	FABRIC	CODE
multistrato marino rivestito in espanso ricoperto con tela idro Marine plywood covered in polyurethane foam and waterproof fabric Marine-Sperrholz bezogen in Schaumstoff und bedeckt mit Hydro-Leinenstoff pali in iroko, poles in iroko, Iroko-Stangen fasce in tessuto, fabric straps, Stoffbänder	su richiesta on request auf Anfrage	CLASSE A	C51004CUA
		CLASSE B	C51004CUB
		CLASSE C	C51004CUC

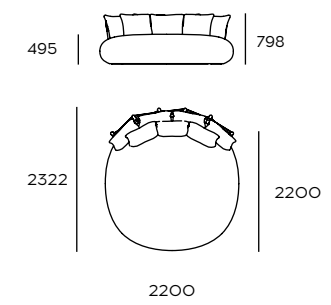

Divano 3 posti
sofa, 3-Sitzer-Sofa

MATERIALS	COLORS/FINISHES	FABRIC	CODE
multistrato marino rivestito in espanso ricoperto con tela idro Marine plywood covered in polyurethane foam and waterproof fabric Marine-Sperrholz bezogen in Schaumstoff und bedeckt mit Hydro-Leinenstoff pali in iroko, poles in iroko, Iroko-Stangen fasce in tessuto, fabric straps, Stoffbänder	su richiesta on request auf Anfrage	CLASSE A	C51008CUA
		CLASSE B	C51008CUB
		CLASSE C	C51008CUC

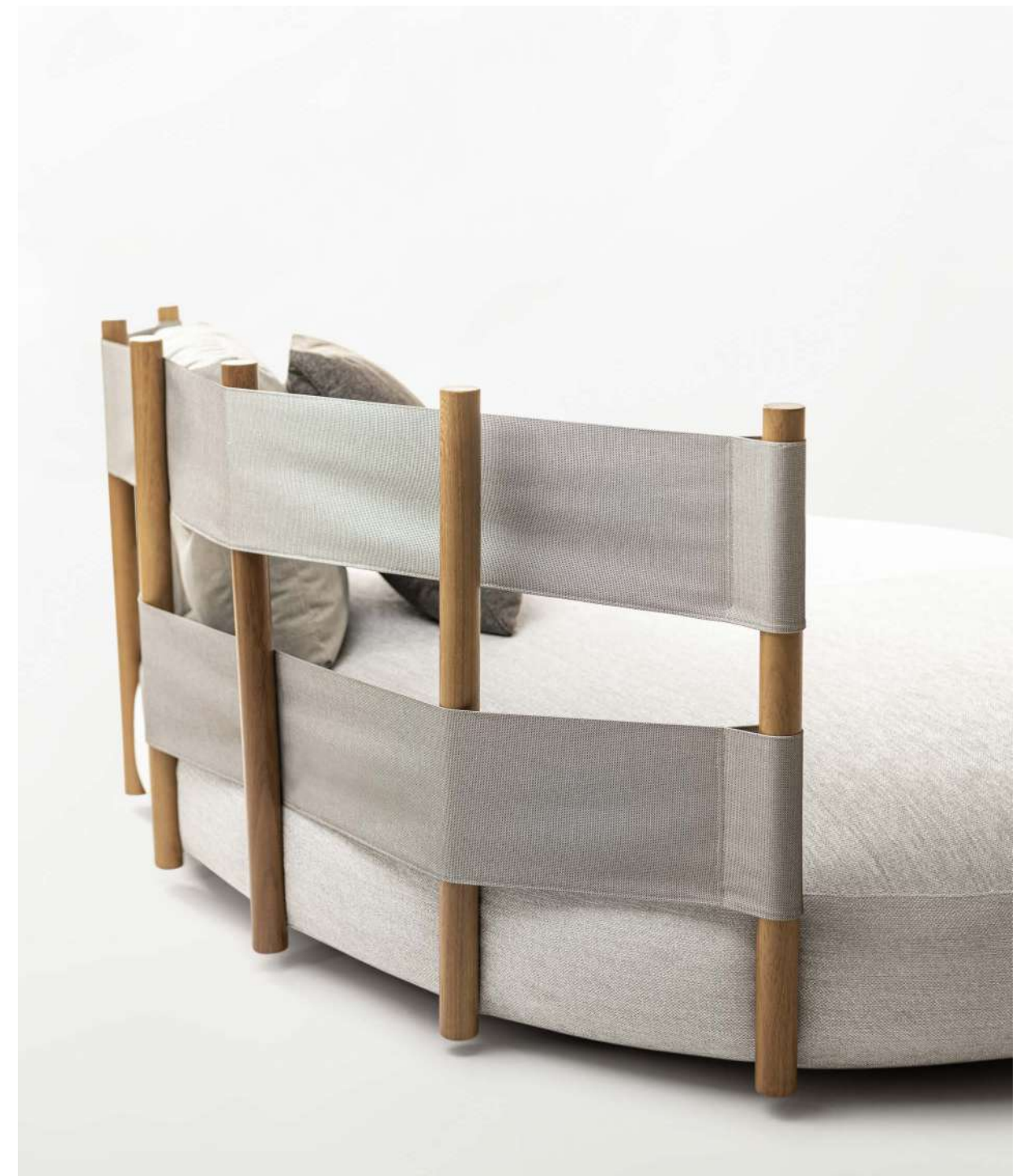

Cuscino bracciolo
cushion for armrest,
Armlehnenkissen

FABRIC	CODE
CLASSE A	C55009SBA
CLASSE B	C55009SBB
CLASSE C	C55009SBC

Cuscino volante
loose cushion, Kissen Volant

FABRIC	CODE
CLASSE A	C55009VA
CLASSE B	C55009SVB
CLASSE C	C55009SVC



Fusion

Design Marcello Ziliani

Fusion trae spunto dall'immagine di morbidi solidi che si fondono uno nell'altro generando figure plastiche e scultoree. Schienali e braccioli di questa serie di imbottiti sono come incastonati nella base dalla quale emergono a costituire delle sedute iconiche, estremamente confortevoli e funzionali.

Fusion draws inspiration from the image of soft blocks that merge together to form flexible and sculpteristic shapes. The backs and arms of this upholstered range appear as if they are set in a base from which iconic seating emerges, extremely comfortable and functional.

Fusion geht von dem Bild weicher Körper aus, die ineinander übergehen und plastische, skulpturale Figuren bilden. Die Rücken- und Armlehnen dieser Polsterserie sind in den Sockel eingelassen, aus dem sie herausragen und ikonische, äußerst bequeme und funktionelle Sitze bilden.



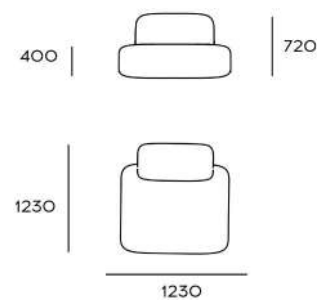
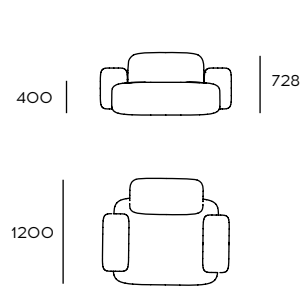

Poltrona con braccioli
armchair, Sessel mit Armlehnen

Poltrona senza braccioli
slipper chair, Sessel ohne Armlehnen

MATERIALS	COLORS FINISHES	FABRIC	CODE
multistrato marino rivestito in espanso ricoperto con tela idro Marine plywood covered in polyurethane foam and waterproof fabric Marine-Sperrholz bezogen in Schaumstoff und bedeckt mit Hydro-Leinenstoff	su richiesta on request auf Anfrage	CLASSE A	C5200901CUA
		CLASSE B	C5200901CUB
		CLASSE C	C5200901CUC

MATERIALS	COLORS FINISHES	FABRIC	CODE
multistrato marino rivestito in espanso ricoperto con tela idro Marine plywood covered in polyurethane foam and waterproof fabric Marine-Sperrholz bezogen in Schaumstoff und bedeckt mit Hydro-Leinenstoff	su richiesta on request auf Anfrage	CLASSE A	C52056CUA
		CLASSE B	C52056CUB
		CLASSE C	C52056CUC

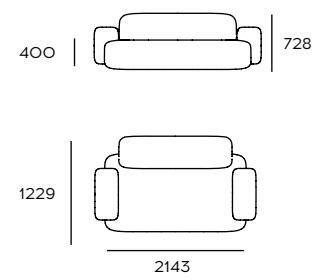

Divano con braccioli
couch with armrests, Sofa mit Armlehnen

MATERIALS	COLORS/FINISHES	FABRIC	CODE
multistrato marino rivestito in espanso ricoperto con tela idro Marine plywood covered in polyurethane foam and waterproof fabric Marine-Sperrholz bezogen in Schaumstoff und bedeckt mit Hydro-Leinenstoff	su richiesta on request auf Anfrage	CLASSE A	C5200801CUA
		CLASSE B	C5200801CUB
		CLASSE C	C5200801CUC

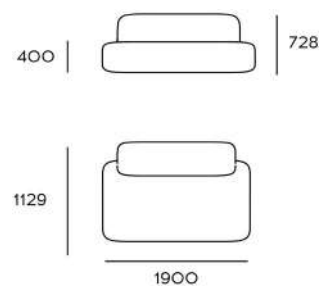

Divano senza braccioli
couch without armrests, Sofa ohne Armlehnen

MATERIALS	COLORS FINISHES	FABRIC	CODE
multistrato marino rivestito in espanso ricoperto con tela idro. Marine plywood covered in polyurethane foam and waterproof fabric. Marine-Sperrholz bezogen in Schaumstoff und bedeckt mit Hydro-Leinenstoff	su richiesta on request auf Anfrage	CLASSE A	C5200701CUA
		CLASSE B	C5200701CUB
		CLASSE C	C5200701CUC

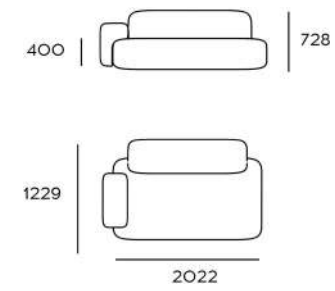

Divano con bracciolo dx
couch with right armrest, Sofa mit rechter Armlehne

MATERIALS	COLORS FINISHES	FABRIC	CODE
multistrato marino rivestito in espanso ricoperto con tela idro. Marine plywood covered in polyurethane foam and waterproof fabric. Marine-Sperrholz bezogen in Schaumstoff und bedeckt mit Hydro-Leinenstoff	su richiesta on request auf Anfrage	CLASSE A	C52058DXCUA
		CLASSE B	C52058DXCUB
		CLASSE C	C52058DXCUC

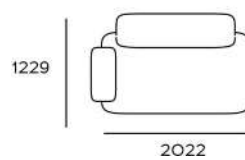
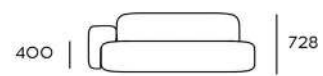

Divano con bracciolo dx
couch with right armrest, Sofa mit rechter Armlehne

MATERIALS	COLORS FINISHES	FABRIC	CODE
multistrato marino rivestito in espanso ricoperto con tela idro, Marine plywood covered in polyurethane foam and waterproof fabric Marine-Sperrholz bezogen in Schaumstoff und bedeckt mit Hydro-Leinenstoff	su richiesta on request auf Anfrage	CLASSE A	C52O58XCUA
		CLASSE B	C52O58XCUB
		CLASSE C	C52O58XCUC

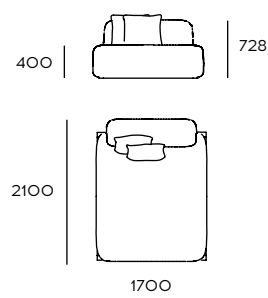

Daybed
daybed

MATERIALS	COLORS/FINISHES	FABRIC	CODE
multistrato marino rivestito in espanso ricoperto con tela idro, Marine plywood covered in polyurethane foam and waterproof fabric Marine-Sperrholz bezogen in Schaumstoff und bedeckt mit Hydro-Leinenstoff	su richiesta on request auf Anfrage	CLASSE A	C52O28O1CUA
		CLASSE B	C52O28O1CUB
		CLASSE C	C52O28O1CUC

Blend

Una collezione di sdraio che reinterpreta un oggetto tipico della tradizione, esaltato dall'utilizzo di colori, finiture e tessuti naturali.

A collection of deckchairs that reinterpret a typical traditional object, emphasised by the use of colours, finishes and natural fabrics.

Eine Liegestuhl-Kollektion, die ein typisches traditionelles Objekt neu interpretiert und durch die Verwendung von natürlichen Farben, Oberflächen und Stoffen aufwertet.

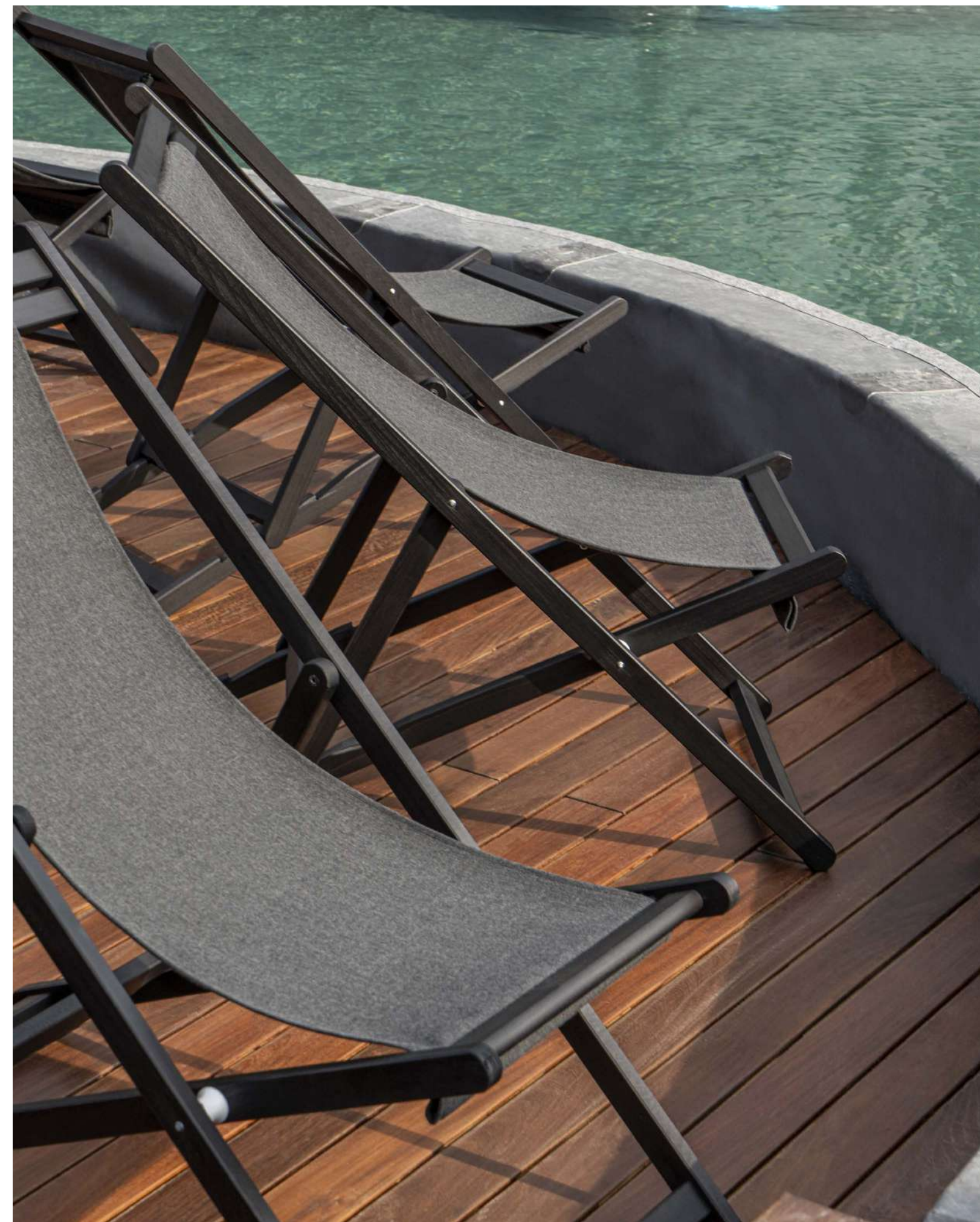

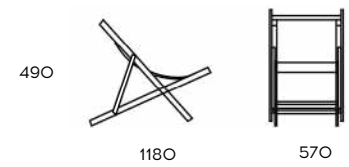

Sdraio pieghevole
folding deckchair, Klappliegestuhl

COLORS	MATERIALS	CODE
grigio grey, Grau		C640002
blu blue, Blau	faggio tinto e tessuto stained beech and fabric, befleckte Buche und Stoff	C640003
nero carbon nero carbon, Kohlenschwarz		C640001

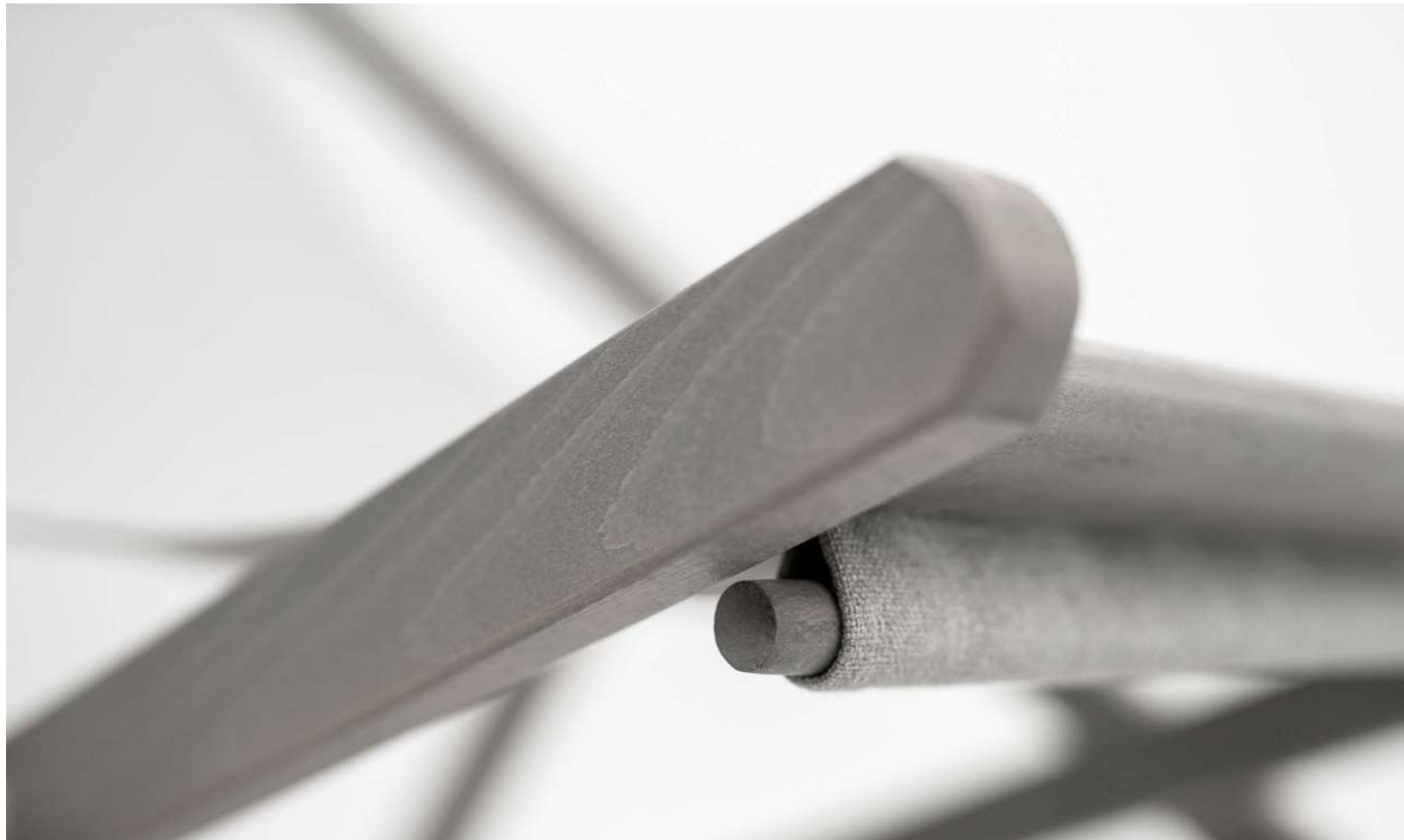

Sedia Y

Sedia salvaspazio che si appiattisce occupando un minimo ingombro, pratica e senza tempo, la sedia da regista rimane un classico delle sedie pieghevoli per qualsiasi stile.

A space saving chair that folds down with minimum encumbrance, practical and timeless, this director's chair remains a classic amongst folding chairs of any kind.

Der Regiestuhl ist ein platzsparender, praktischer und zeitloser Klappstuhl, der für jeden Stil geeignet ist.



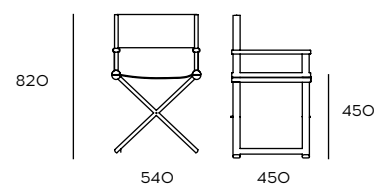

Sedia
chair, stuhl

MATERIALS	COLORS/ FINISHES	CODE
Faggio e batyline o tessuto, stained beech and batyline or fabric, gebeizte Buche und Batyline oder Stoff	chiaro, light colour finish, helle Farbe	C48O29O1C
	medio, medium colour finish, mittlere Farbe	C48O29O1M
	scuro, dark colour finish, dunkle Farbe	C48O29O1S



Panama

Archivio storico

Ispirata alle superfici rustiche e ai rilassanti dintorni, la nuova collezione Panama si presenta con un proposta di ispirazione naturale.

Aggiorna il tuo patio, giardino o giardino d'inverno con nuove finiture naturali e senza tempo.

Inspired by rustic surfaces and soothing surroundings, the Panama collection come in profusion of nature inspired furniture. Give your terrace, garden or other outdoor area an exotic upgrade.

Angeregt von rustikalen Oberflächen und beruhigenden Umgebungen erscheint die neue Outdoor-Kollektion Panama mit einem Füllhorn an naturinspirierten Möbeln und Dekor.

Verleihen Sie Ihrer Terrasse, Ihrem Garten oder Wintergarten durch neue ein Upgrade in Form eines natürlichen und zeitlosen Finishes.

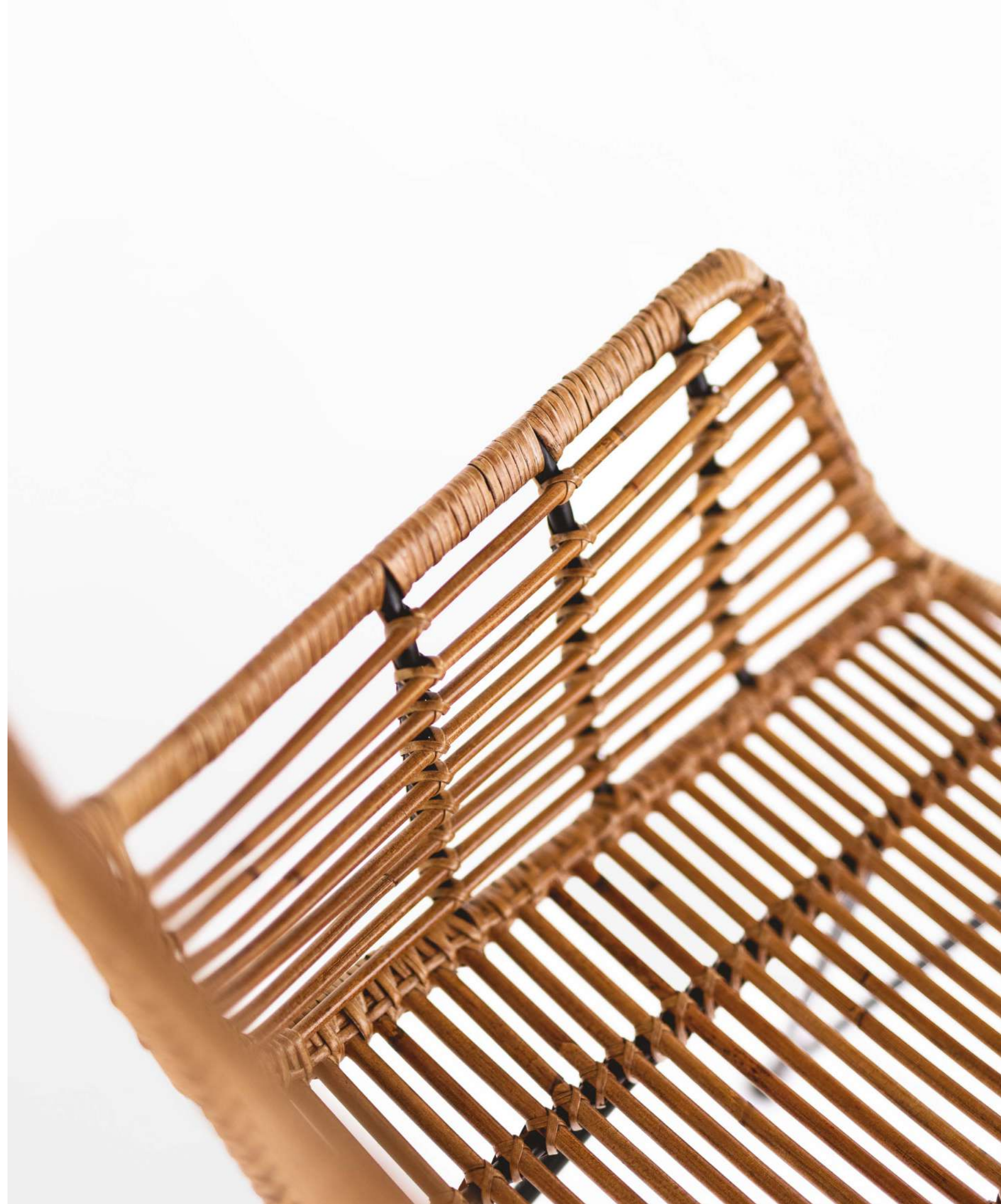

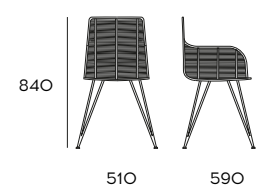
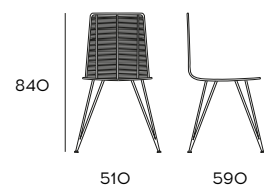

Sedia
chair, stuhl

MATERIALS	CODE
rattan e metallo, rattan and steel, rattan und Metall	913201001

Poltrona XL
armchair, armlehnstuhl

MATERIALS	CODE
rattan e metallo, rattan and steel, rattan und Metall	913202001

Wunderkammer Collection

La collezione Wunderkammer comprende Folding un tavolino pieghevole composto da una base in legno e un vassoio tondo in alluminio finitura stone washed che rende pratico il servizio e da un gazebo.

Il gazebo entra così a far parte della nuova collezione per l'outdoor SchönhuberFranchi.

Di fattura leggera, si distingue per il design essenziale, caratteristica che lo rende un ottimo "punto panoramico" adattabile a qualsiasi ambiente esterno.

The Wunderkammer collection includes Folding, a folding table made up of a wooden base and a round stone-washed aluminum tray that makes service practical, and a gazebo.

The gazebo becomes part of the new one SchönhuberFranchi outdoor collection. Lightweight, it stands out for its design essential, a feature that makes it an excellent "panoramic point" adaptable to any external environment.



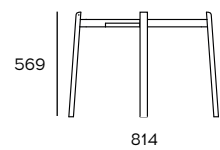
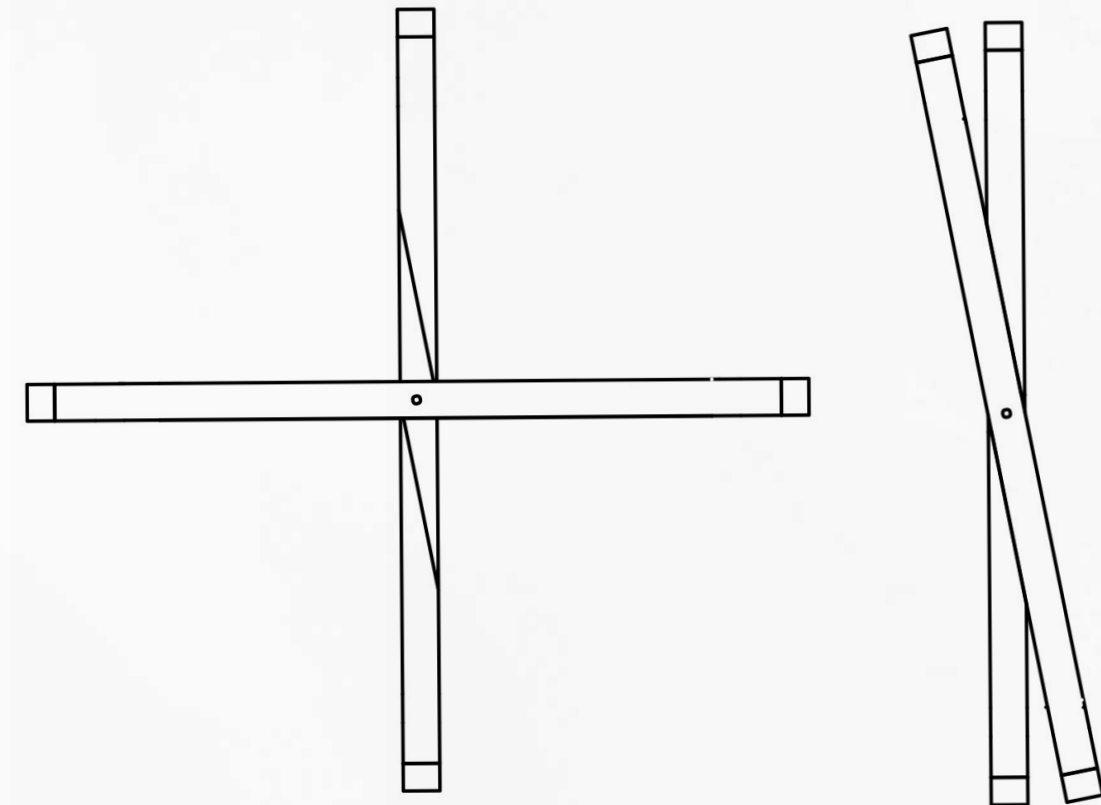

569

814

Tavolo pieghevole
folding table, Klapp Tisch

MATERIALS	CODE
frassino, Ash, Asche	C5200001

Vassoio in alluminio finitura stone washed
Aluminium tray stone washed finishing,
Aluminium-Tablett Stone Washed-Finish

MATERIALS	CODE
Alluminio finitura stone washed Aluminium stone washed finishing Aluminium Stone Washed-Finish	GL313LL



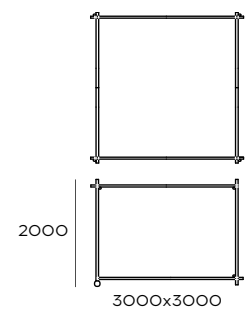

Gazebo
gazebo

MATERIALS	COLORS/FINISHES	CODE
metallo verniciato	su richiesta	C5200101

Tendaggio

CODE
C5200101T



Calypso

Design Luca Trazzi

Forme innovative, linee morbide e fluide per arredi dal design accattivante e sicuramente originale.

Sculture uniche, volumi modellati in maniera geniale danno vita ad angoli inediti ed esclusivi.

Innovative shapes, soft and fluid lines for furniture with an attractive and certainly inventive design.

Unique sculptures, volumes modelled in an ingenious way, create original and exclusive corners.

Innovative Formen, sanfte und fließende Linien mit einem attraktiven und originellen Design.

Einzigartige Skulpturen - genial modellierte Volumen - hauchen neuen und exklusiven Bereichen Leben ein.





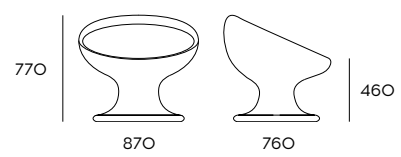

Poltrona
lounge chair, sessel

COLORS	MATERIALS	CODE
tortora, warm gray, Warmes Grau	midollino sint. polyrattan Polyrattan	C5807104
blu, blue, blau		C5807103
salvia, green, Grün		C580716019

HUG

Design Simone Micheli

Il delicato color grigio perla dona agli ambienti una luce particolare. L'atmosfera è rischiarata e armoniosa. Ancora una volta l'eleganza, il design e il comfort si fondono in un mix unico per una firma di sicuro prestigio.

The delicate pearl grey colour creates a special light. The atmosphere is light and harmonious. Once again elegance, design and comfort blend in a unique combination under an exclusive name.

Zartes Perlgrau verleiht dem Ambiente ein besonderes Licht. Die Atmosphäre ist erleuchtet und harmonisch. Erneut vereinen sich Eleganz, Design und Komfort in einem einzigartigen Mix für einen prestigereichen Namen.



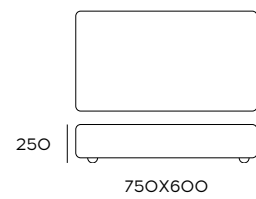
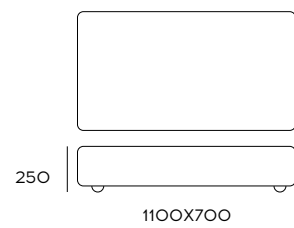

Tavolino
side table, beistelltisch

MATERIALS	CODE
jolan	C58O1117

Tavolino
side table, beistelltisch

MATERIALS	CODE
jolan	C58O11217

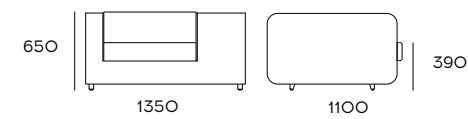

Poltrona
armchair, sessel

MATERIALS	CODE
jolan	C58O9417

Cuscini
pillow, kissen

FABRIC	CODE
classe A	C58O11OCUA

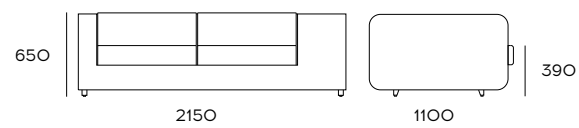

Divano a due posti
2er- sofa, Sofa (2 Plätze)

MATERIALS	CODE
jalan	C58010117

Cuscini
pillow, kissen

FABRIC	CODE
classe A	C580101CUA

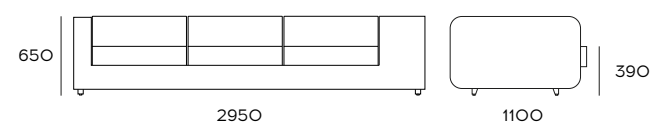

Divano a tre posti
3er- sofa, Sofa (3 Plätze)

MATERIALS	CODE
jalan	C5809517

Cuscini
pillow, kissen

FABRIC	CODE
classe A	C58095CUA

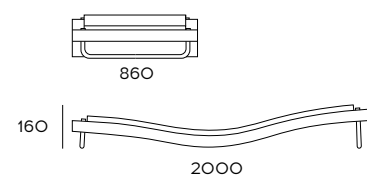
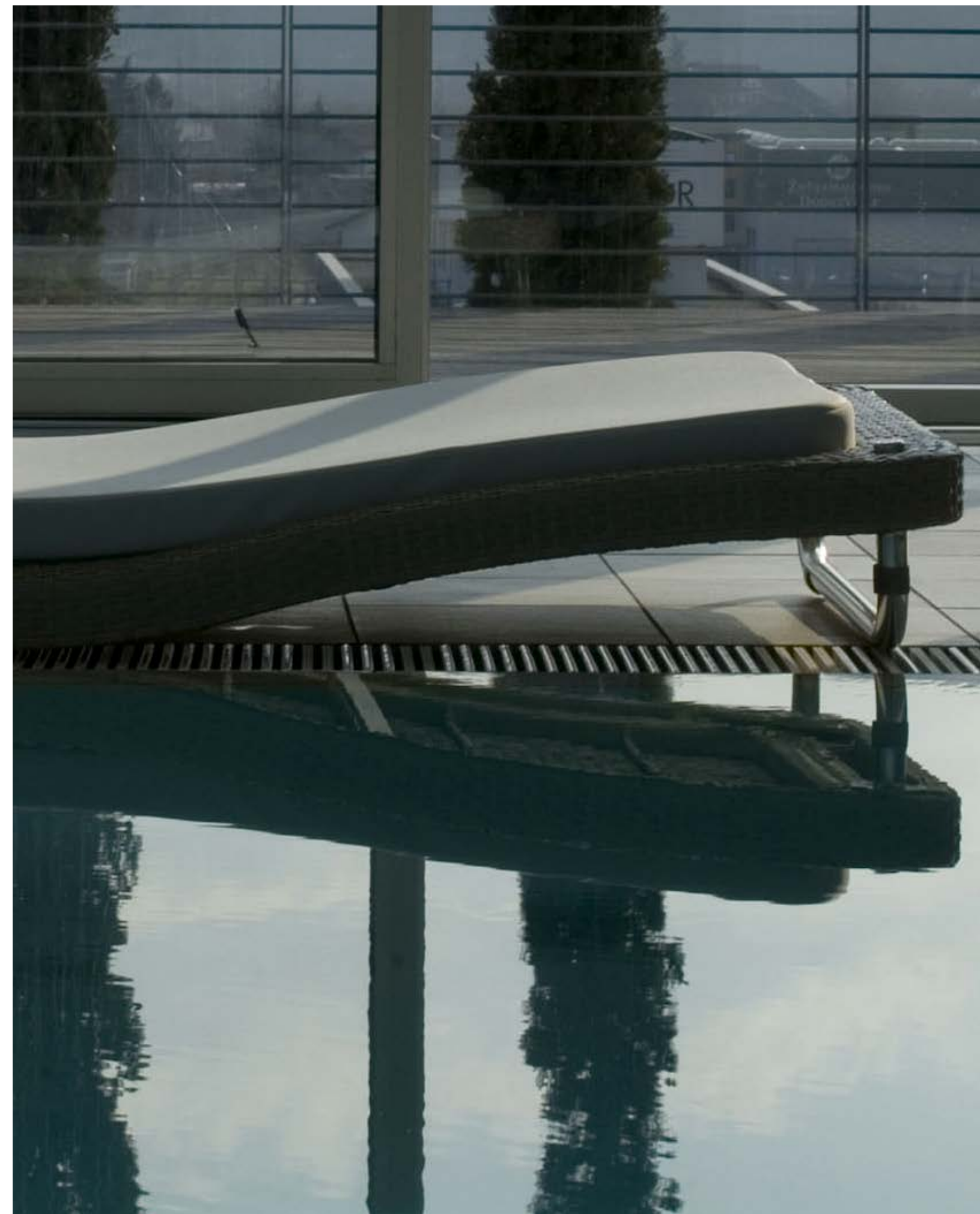

Letfino
sun lounger, sonnenliege

MATERIALS	CODE
jalán	C5809817

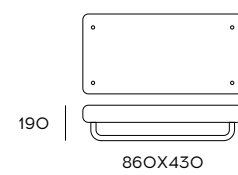

Tavolino per lettino
side table, beistelltisch

MATERIALS	CODE
jalán	C5809617

JALAN 1

Design Matteo Thun

Il bianco o una nuance cangiante per un tocco di charme esotico. Gli spazi prendono vita con energia e vigore per donare agli Ospiti un caldo relax per il corpo e per lo spirito.

A shimmering shade for a touch of exotic charm. Spaces take form with energy and vigour to treat Guests to a warmth that relaxes both body and spirit.

Eine changierende Nuance für einen Touch exotischen Charmes. Räume, die Leben und Kraft erhalten, um den Gästen Entspannung in Körper und Geist zu schenken.



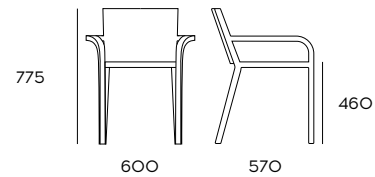
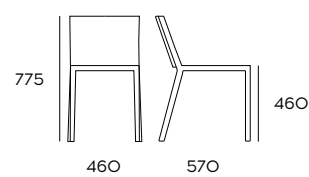

Sedia impilabile Van Gogh
stackable dining chair, stapelbarer stuhl

COLORS	MATERIALS	CODE
bianco, white, weiß	jolan	C5805205
titanio, titanium		C5805218

Poltroncina impilabile Van Gogh
stackable dining chair, stapelbarer stuhl

COLORS	MATERIALS	CODE
bianco, white, weiß	jolan	C5805105
titanio, titanium		C5805118

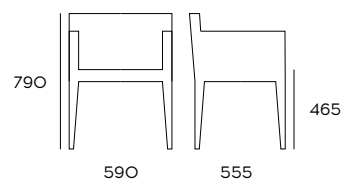

Poltroncina Monet
dining armchair, armlehnstuh

COLORS	MATERIALS	CODE
bianco, white, weiß	jolan	C5804705
titanio, titanium		C5804718



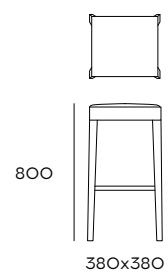

Sgabello Sisley
barstool, barhocker

COLORS	MATERIALS	CODE
bianco, white, weiß	jolan	C5805405
titanio, titanium		C5805418

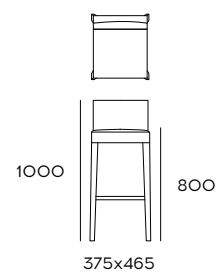

Sgabello Cezanne
barstool, barhocker

COLORS	MATERIALS	CODE
bianco, white, weiß	jolan	C5805305
titanio, titanium		C5805318

JALAN 2

Design Lorenzo Bellini

Candore, freschezza, brio e finezza.
Atmosfere delicate ricreate da forme e
linee sinuosamente disegnate: l'armonia
espressa attraverso la leggerezza e la
raffinatezza.

Candour, freshness, character and
elegance. Delicate atmospheres recreated
by forms and lines sinuously designed:
harmony expressed through lightness and
stylishness.

Klarheit, Frische, Spritzigkeit und Finesse.
Atmosphären, die aus sinnlichen Formen
und Linien kreiert werden: der Ausdruck von
Harmonie durch Leichtigkeit und Raffinesse.



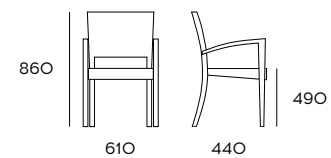

Sedia impilabile con braccioli Mascagni
stackable chair with arms, stapelbarer stuhl mit Armlehnen

COLORS	MATERIALS	CODE
bianco, white, weiß	jalon	C58O149O5
titanio, titanium		C58O14918

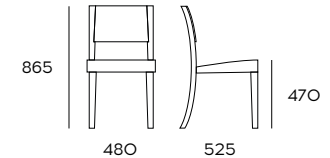

Sedia impilabile Mascagni
stackable chair, stapelbarer stuhl

COLORS	MATERIALS	CODE
bianco, white, weiß	jalon	C58O45O5
titanio, titanium		C58O4518

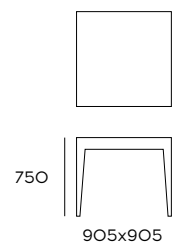

Tavolo quadrato
square table / quadratischer esstisch

COLORS	MATERIALS	CODE
bianco, white, weiß	jalan	C5803505A
titanio, titanium		C5803518A

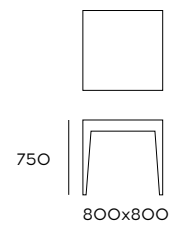

Tavolo quadrato
square table / quadratischer esstisch

COLORS	MATERIALS	CODE
bianco, white, weiß	jalan	C5803605A
titanio, titanium		C5803618A

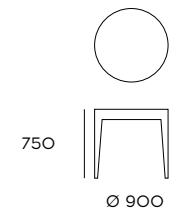

Tavolo tondo
round table, esstisch rund

COLORS	MATERIALS	CODE
bianco, white, weiß	jalan	C5803705A
titanio, titanium		C5803718A

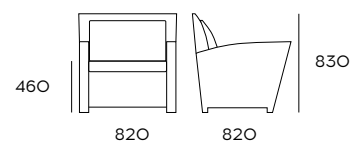

Poltrona Mozart
armchair, sessel

COLORS	MATERIALS	CODE
bianco, white, weiß	jalan	C5800205
titanio, titanium		C5800218

Cuscini
pillow, kissen

FABRIC	CODE
classe A	C58002CUA
classe B	C58002CUB

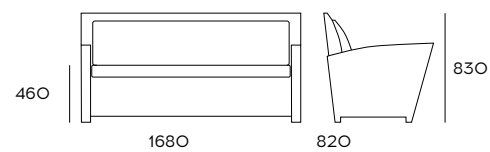

Divano Mozart
sofa

COLORS	MATERIALS	CODE
bianco, white, weiß	jalan	C5800105
titanio, titanium		C5800118

Cuscini
pillow, kissen

FABRIC	CODE
classe A	C58001CUA
classe B	C58001CUB

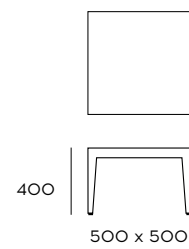
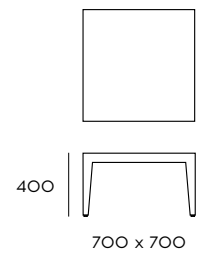

Tavolino basso Bizet
coffee table, kaffeetisch

COLORS	MATERIALS	CODE
bianco, white, weiß	jalan	C58015005
titanio, titanium		C58015018

Tavolino basso Bizet
coffee table, kaffeetisch

COLORS	MATERIALS	CODE
bianco, white, weiß	jalan	C5803405A
titanio, titanium		C5803418A

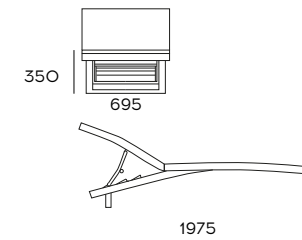

Letino Händel
sunbed, sonnenliege

COLORS	MATERIALS	CODE
bianco, white, weiß	jalan	C5803105
titanio, titanium		C5803118

Basic 2

archivio storico

Geometria, leggerezza, colore: Basic 2 è una collezione che cambia continuamente per rinnovare l'estetica dei luoghi, per rallegrare gli spazi. Forme elementari in alluminio leggero, con cromatismi nuovi, per coordinarsi all'ambiente esistente in giochi senza limiti, se non quelli della fantasia.

Geometry, lightness, colour: Basic 2 is a collection that continues to change and renew the look of places and bring spaces to life. Elementary shapes in light-weight aluminium, with new colours coordinate with the existing environment to effects that know no limits, except those of the imagination.

Geometrie, Leichtigkeit, Farbe: Basic 2 ist eine Kollektion, die sich kontinuierlich verändert und es vermag, die ästhetik von Standorten aufzufrischen und ein heiteres Ambiente zu schaffen. Bei den Kombinationen der elementare Formen aus leichtem Aluminium in sechs modischen Farben sind der Phantasie keine Grenzen gesetzt.



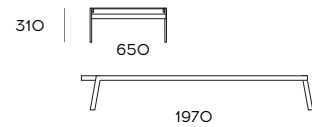

Letino
sun lounger, sonnenliege

MATERIALS	COLORS/FINISHES	CODE
alluminio verniciato e batyline, painted aluminum and batyline, lackiertes Aluminium und Batyline	su richiesta, on request, auf Anfrage	C96500020
	alluminio verniciato bianco, painted aluminum white, weiß lackiertes Aluminium	C965000202
	batyline bianco, white batyline, weiß Batyline	
	alluminio verniciato testa di moro, brown painted aluminum, Braun lackiertes Aluminium	C965000203
	batyline beige, beige batyline, Beige Batyline	





Ombrelloni

Archivio storico

Gli ombrelloni SF sono straordinariamente robusti e funzionali. Si aprono con facilità grazie a un sistema di pulegge. I loro ripari resistenti ai raggi UV e di facile manutenzione respingono lo sporco e l'acqua. E tutti i materiali sono di altissima qualità.

SF sunshades are remarkably robust and functional. They open with ease thanks to an ingenious pulley system. Their UV-protected, easy-care canopies repel dirt and water. And all materials are of the highest quality.

Sonnenschirme von SF sind bemerkenswert robust und funktional. Dank eines genialen Flaschenzugsystems lassen sie sich mühelos öffnen. Ihre UV-geschützte pflegeleichte Bespannung ist schmutz- und wasserabweisend. Und alle Materialien sind von höchster Qualität.



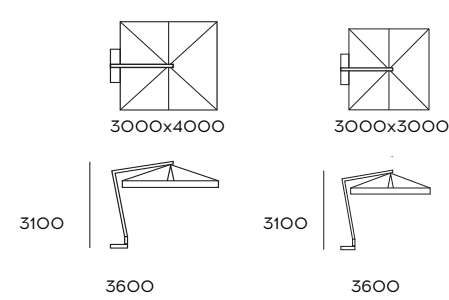

Ombrellone a braccio Ecrù
side arm umbrella, seitenarmschirm

MATERIALS	CODE
telaio in iroko, base in cemento graniglia, tessuto impermeabilizzato, iroko frame, grit base, waterproofed fabric, Irokoholz, granuliert, Zementbasis, wasserfester Stoff	C67003CB
	C67004CB

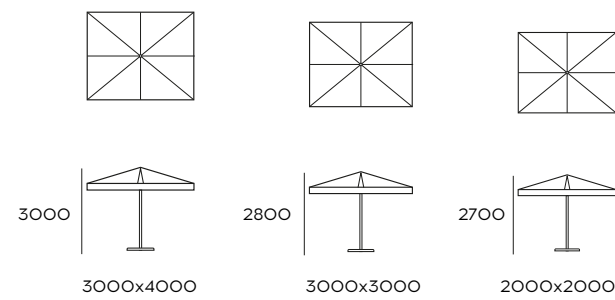

Ombrellone a palo centrale Ecrù
side with central arm, sonnenschirm mit zentralem

MATERIALS	CODE
telaio in iroko, base in cemento graniglia, tessuto impermeabilizzato, iroko frame, grit base, waterproofed fabric, Irokoholz, granuliert, Zementbasis, wasserfester Stoff	C66002CB
	C66003CB
	C66004CB

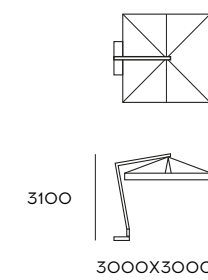

Ombrellone a braccio Ecrù
side arm umbrella, seitenarmschirm

MATERIALS	CODE
alluminio, aluminium, Aluminium	C669002CB

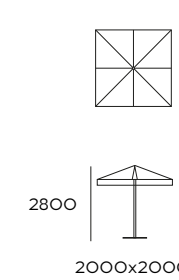

Ombrellone a palo centrale
side with central arm, sonnenschirm mit zentralem

MATERIALS	CODE
alluminio, aluminium, Aluminium	C662020CB

Progetto grafico Graph.X

Styling Sirine Graiaa

Foto Nicolò Brunelli / Lara Caffi / Sirine Graiaa

Thanks to :

Hotel Resort Quellenhof San Martino in Passiria (BZ)

Hotel Villa Eden Merano (BZ)

Hotel Quellenhof See Lodge San Martino in Passiria (BZ)