

ASCOLIA
VISION OF EXCELLENCE

HOUSEKEEPING

ROOM SERVICE

LOBBY

www.ascolia.com

ASCOLIA

We invest our energy in searching innovative solutions by thinking differently.

The existing is challenged by designing ergonomic, user friendly and ecological equipment.

Our main goal is to produce fantastic hospitality products.

Be our guest and share our passion!

DID YOU KNOW?

Light as air, fluttering with ease, harmonious and efficient, a necessity to its environment, the Ascolia is a butterfly that originates from South America.

What a wonderful source of inspiration for our designers ...

This catalogue has been carefully compiled, just like each Ascolia product. The Ascolia Team wishes you a pleasant read.

At your service,
The Ascolia Team



TABLE OF CONTENTS

OUR COMMITMENTS 5

MATERIALS AND CHARACTERISTICS 9

HOUSEKEEPING 11

12 **Traditional range**

Atlas 520-650-800-1000-1200
Motorisation Atlas
Saturne
Corellia mono & Corellia duo
Hermia

30 **Bag holders**

Callisto and Callisto X
Protea Mono-Duo-Trio-Quattro
Mars

39 **Exclusive range “La malle”**

Gulliver 650-800
Despina 650-800
Motorisation Gulliver & Despina
Cortes
Magellan

52 **Small corridors range**

Pluton 520-650
Vega
Minos 125-300

58 **Transport, storage and distribution of clean linen**

Antarès
Metis

60 **Collection of soiled linen**

Missouri
Messipi
Sirius
Felucia

64 **Container trolleys**

Leda

65 **Maintenance**

Lavezzi

66 **Housekeeping complements**

Daphnis
Vesta

ROOM SERVICE 69

70 **Minibar restocking**

Traditional range
Balaton 520-800

Exclusive range “La malle”

Lugano 650-800

Motorisation Balaton & Lugano

76 **Room service table**

Montebello
Onega
Lagoon

80 **Rolling tables**

Michigan
Baringo

80 **Racking trolleys**

Baïkal
Victoria
Aral

LOBBY 87

88 **Luggage trolleys**

Everest
Motorisation
Vesuvio
Fuji
Vulcano
Stromboli
Ubinas

102 **Guidance**

Luxor
Crown
Abydos
Dikos

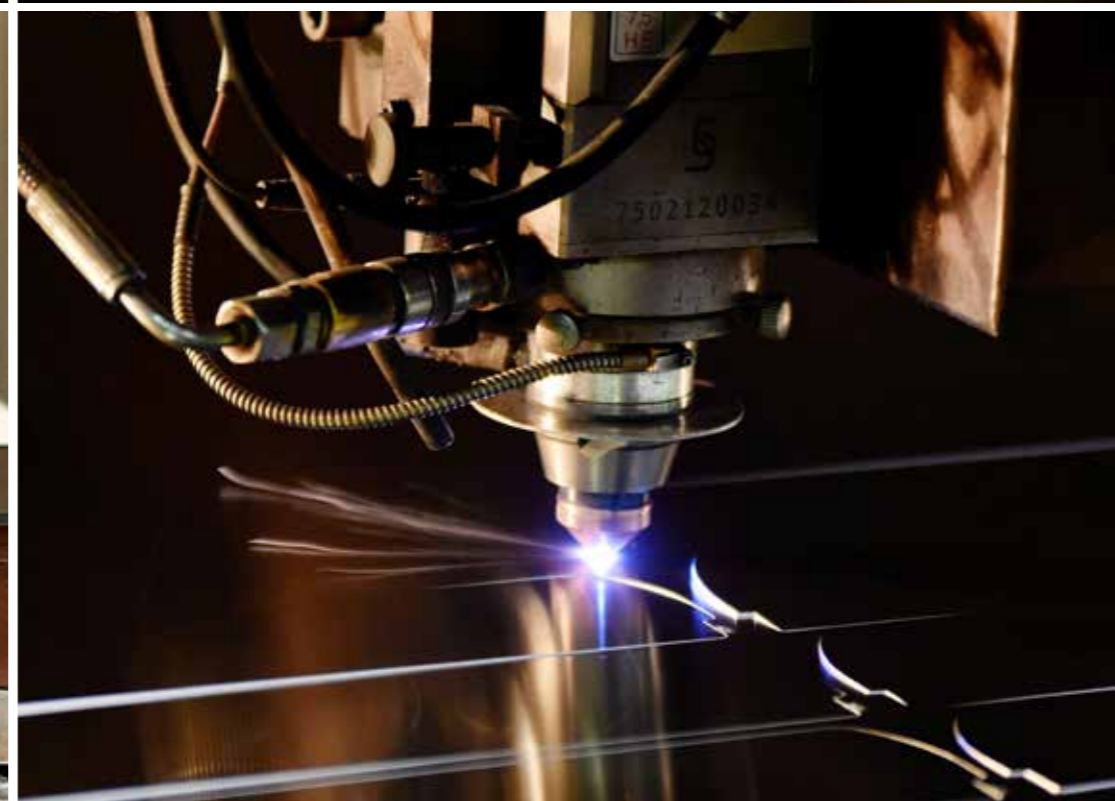

OUR COMMITMENTS

1 TO LISTEN

Ascolia wishes to be available for you and proposes solutions that correspond to your needs and processes.

2 INNOVATION AND FLEXIBILITY

Ascolia uses modern materials and technologies and is constantly searching ways to improve manoeuvrability, ergonomics and functionality. With every creation we challenge the existing by thinking differently. We strive to improve your daily tasks with functional and ergonomic solutions. Please be our guest!

3 DESIGN AND ERGONOMICS

The design of your establishment is the result of a careful study with each detail having received particular attention. Mobile furniture, often seen by your customers, must be in perfect harmony with its surroundings. Pure and sober lines are the visible witnesses of this. The user will appreciate the comfort and manoeuvrability.

4 COLLABORATION

We believe in the power of our team, where everybody takes an active role in the success of the finished project.

OUR COMMITMENTS

5 COMPETENCES AND QUALITY

All of our products are assembled and controlled in our factories before expedition. The affixing of our label at the end of the production line is a warrant of quality. Ascolia is based on almost a century's worth of traditional quality and know-how. Its team members are proud to export their products to over 80 countries.

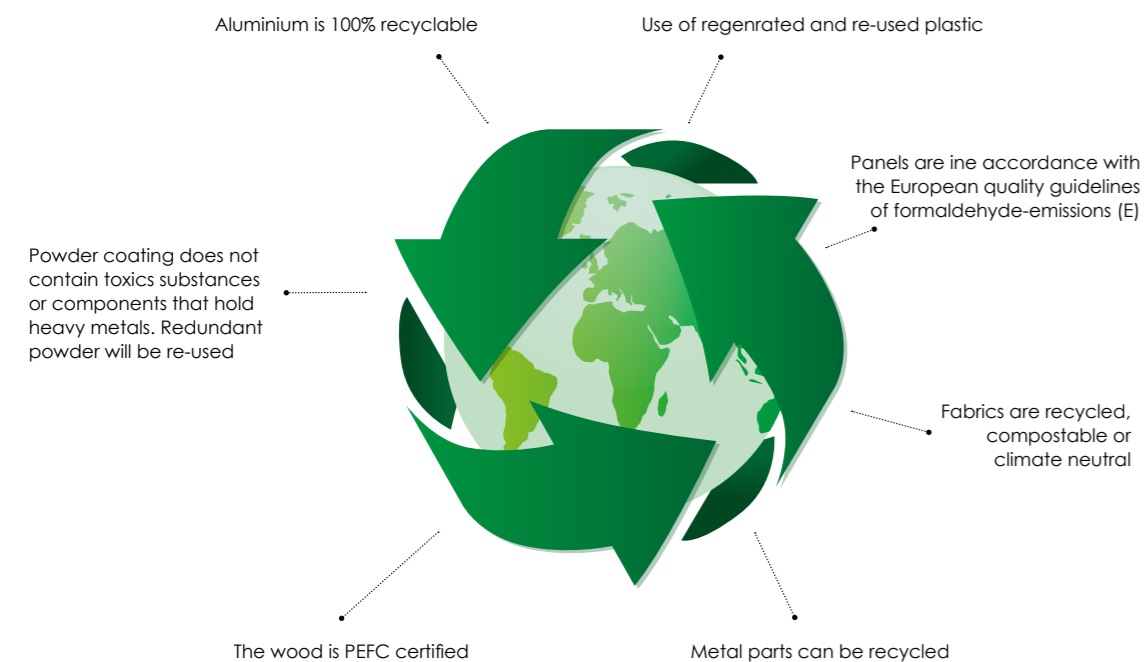

6 DURABILITY

The constituent components of our furniture are carefully selected, and their manufacturing is respectful of the environment. They are all recyclable.



7 NETWORK

Ascolia is present in Belgium, France, Spain and Dubai but is also represented by a widespread network of agents located in many European and around the world.

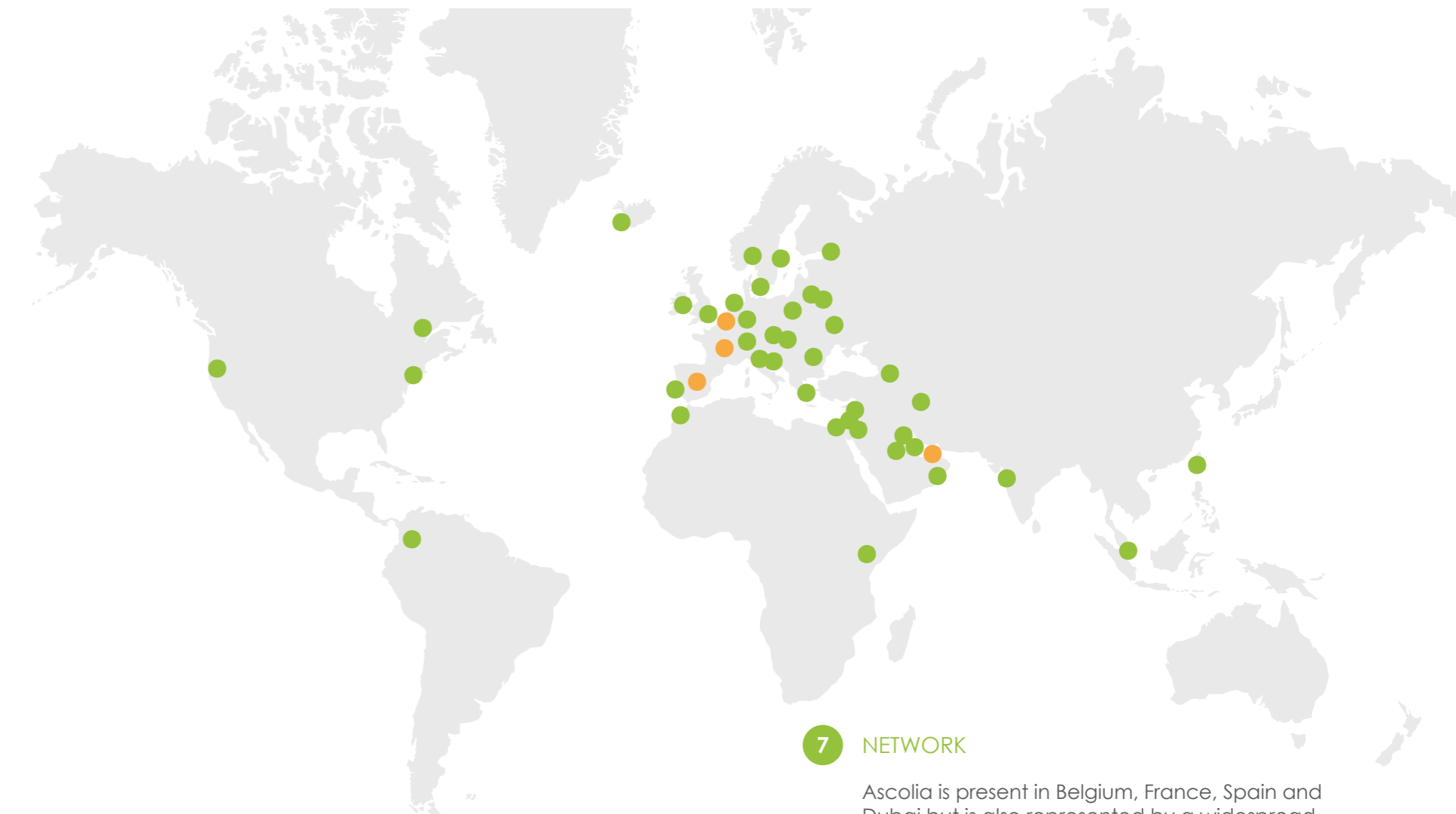



MATERIALS AND CHARACTERISTICS

1 STRUCTURE IN ANODISED ALUMINIUM

Aluminium is a noble, light and resistant material. Anodising it gives it an excellent resistance to scratches, chemical agents and saline corrosion. It is used in particular in the food industry and aeronautics. Aluminium is 3 times lighter than steel and is indefinitely recyclable.

2 COMPACT PANEL PARTITION WALLS

These finishing panels offer a multitude of choices when it comes to color and very life-like wood aspects. They resist to shocks, scratches, humidity and are very light.

3 WHEELS

As essential elements to your comfort, the wheels used are of high quality. They are equipped with precision ball bearings that optimise the manoeuvrability. The tyre of the wheel is adapted to the type of floor in your establishment.

4 MAINTENANCE

The materials chosen are selected to guarantee an easy maintenance and to be resistant to mainstream detergents. The perfectly round angles and the absence of sharp edges facilitate and diminish maintenance.





HOUSEKEEPING

You require a room service that is discrete, tidy and efficient.

By listening to your needs, Ascolia has developed a functional, easy to handle and ergonomic range of housekeeping trolleys.

A very wide range to cater for all your needs.

Multiple storage options, optimisation of space, quality of the finish, each detail has been the subject of careful study focusing on the comfort of the user.

TRADITIONAL RANGE

Atlas 520 - 650 - 800 - 1000

Housekeeping trolley

Matching user friendliness with aesthetics: the Atlas

Capacity: 4 to 10 rooms

Standard equipment:

- 4 models; Atlas 520, 650, 800 and 1000
- Anodised aluminium frame
- 1 open compartment for amenities
- 3 levels for ranging clean linen
- 1 horizontal steering handle
- Grey wrap-around non-marking bumper

Wheels

- Atlas 520 – 4 swivelling wheels Ø125mm with non-marking thermoplastic layer
- Atlas 650 and 800 – 2 fixed and 2 swivelling wheels Ø160mm with non-marking polyamide layer
- Atlas 1000 – 4 swivelling wheels Ø160mm with non-marking polyamide layer combined with a 5th steering wheel

- A choice amongst different finishes (light grey, wenge oak look, black caviar look, almond look)

Options

- Several different options are available; please see pages 18 and 19



Atlas

THE GREAT CLASSICS

MODELS AND REFERENCES

*The last 2 digits refer to the finishes



Atlas 520

Capacity: 4 to 5 rooms

Finish: Caviar

Options: Linen bag holder, garbage bag holder, 2 foldable bases



Atlas 650

Capacity: 5 to 6 rooms

Finish: Almond look

Options: Linen bag holder, garbage bag holder, 2 foldable bases (in folded position), doors, amenities drawer, stationery drawer



Atlas 800

Capacity: 7 to 8 rooms

Finish: Wenge oak look

Options: Linen bag holder and foldable base



Atlas 1000

Capacity: 9 to 10 rooms

Finish: Black caviar look

Options: Linen bag holder, 1 foldable base, doors, amenities drawer, stationery drawer. Motorisation.

Atlas 520

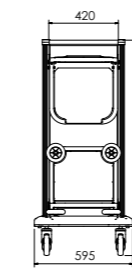
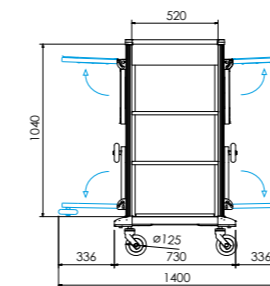

ATLAS 520

Overall dimensions				Reference *
Width (mm)	Depth (mm)	Height (mm)	Wheels Ø (mm)	Base Model
730	595	1300	125	101212xx
Inside dimensions				
Width (mm)	Depth (mm)			
520	420			

Atlas 650

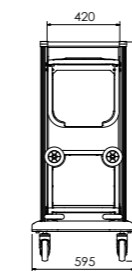
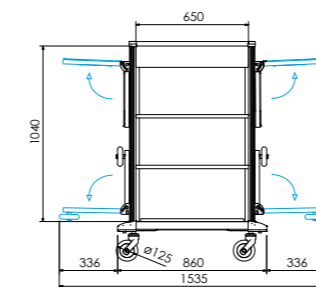

ATLAS 650

Overall dimensions				Reference *
Width (mm)	Depth (mm)	Height (mm)	Wheels Ø (mm)	Base Model
860	595	1320	160	101213xx
Inside dimensions				
Width (mm)	Depth (mm)			
650	420			

Atlas 800

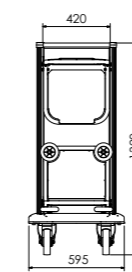
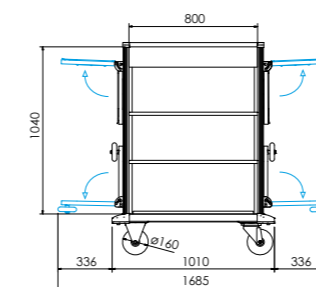

ATLAS 800

Overall dimensions				Reference *
Width (mm)	Depth (mm)	Height (mm)	Wheels Ø (mm)	Base Model
1010	595	1320	160	101214xx
Inside dimensions				
Width (mm)	Depth (mm)			
800	420			

Atlas 1000

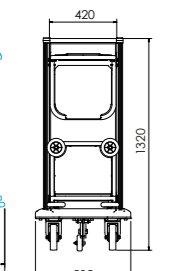
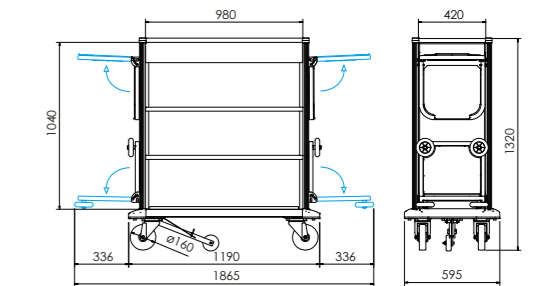

ATLAS 1000

Overall dimensions				Reference *
Width (mm)	Depth (mm)	Height (mm)	Wheels Ø (mm)	Base Model
1190	595	1320	160	101215xx
Inside dimensions				
Width (mm)	Depth (mm)			
980	420			

CONFIGURATION EXAMPLES

(LINEN AND GARBAGE BAG HOLDERS AVAILABLE ON ALL MODELS)



1 Basic model



2 Stationery drawer



3 Amenities drawer



7 Doors



8 Stationery drawer and doors



9 Amenities drawer and doors



4 Amenities and stationery drawer



5 Amenities compartment lid



6 Amenities compartment lid and stationery drawer



10 Amenities drawer, stationery drawer and doors



11 Amenities compartment lid and doors



12 Amenities compartment lid, stationery drawer and doors

ATLAS 520 - 650 - 800 - 1000



Waste bag holder mono and foldable base



Waste bag holder duplo (selective waste sorting) and foldable base



Waste bag curtain



Linen bag holder and foldable base



Foldable base



Linear dividers for amenities compartment/drawer



Amenities drawer



Stationery drawer including linear dividers



Doors with or without lock (opening up to 270°)



Coupling with satellite Callisto or Hermia



Stackable water tight box for tableware



15 or 30l lateral container (bacbis)



Lid for amenities compartment with or without lock



Lateral boxes for various uses



Mop holder and hook



Additional horizontal steering handle



Extra protection via additional swivelling corner pads



5th steering wheel (Atlas 800 only)

FINISHES

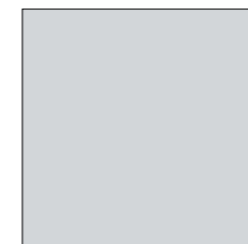

Light grey Ref xx=09



Almond look Ref xx=17



Wenge oak look Ref xx=11

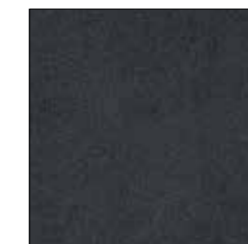

Black caviar look Ref xx=14

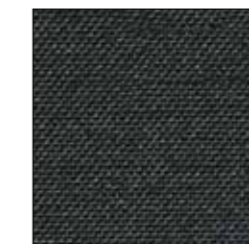

Black

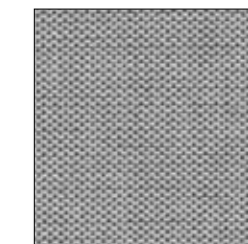

Grey



Brown

LINEN BAG AND GARBAGE BAG CURTAIN COLORS

TRADITIONAL RANGE

Atlas 1200

Housekeeping trolley

Optimised organisation:
one place for each item,
each item its place!

Capacity: 8 to 10 rooms

Standard equipment:

- Anodised aluminium frame
- 4 levels for ranging clean linen
- Other ranging possibilities :
 - 4 drawers for amenities, courtesy trays, stationery,... (height 120mm)
 - 2 drawers for miscellaneous products, chemicals, tableware,... (height 170mm)
 - 4 stationery openings at the top
 - 1 horizontal steering handle
 - Grey wrap-around non-marking bumper
 - 4 swivelling wheels Ø160mm with non-marking polyamide layer combined with a 5th steering wheel
 - A choice amongst different finishes (wenge oak look, black caviar look, almond look, light grey)

Options

- Several different options are available, please see page 22 (Exclusive lid on welcome products compartment, drawers and doors)



Atlas 1200

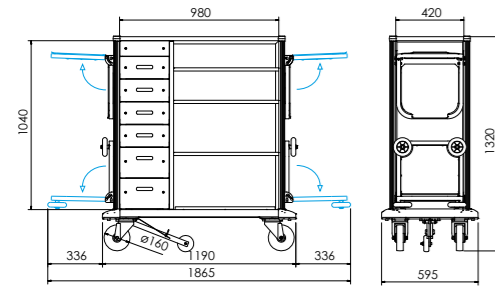

ATLAS 1200

Overall dimensions				Reference *
Width (mm)	Depth (mm)	Height (mm)	Wheels Ø (mm)	Base Model
1190	595	1320	160	101202xx
Inside dimensions				
Width (mm)	Depth (mm)			
980/650	420			

FINISHES

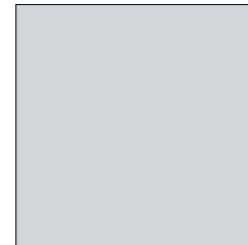
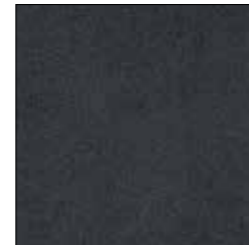
Light grey
Ref xx=09Almond look
Ref xx=17Wenge oak look
Ref xx=11Black caviar look
Ref xx=14

OPTIONS



Waste bag holder mono or duplo (selective waste sorting) and foldable base



Waste bag curtain



Linen bag holder and foldable base



Mop holder and hook



Partitioning for drawers



The ergonomic controller allows you an easy and intuitive use



Characteristics

- Ergonomic controller allows you an easy and intuitive use
- Progressive and silent acceleration
- Safety of use
- Great manoeuvrability; pivots on the spot
- Charging time: 7 hours
- CE certification
- Available on Atlas 800 - 1000 - 1200

Technical specifications

- Power : 240 W
- Maximum forward speed : 5 km/h
- Maximum reverse speed : 3 km/h

TRADITIONAL RANGE

Saturne

Turndown trolley

Standard equipment

- Frame in anodised aluminium
- Doors : opening 270°
- 2 compartments for soiled linen and garbage including lids
- 1 drawer for amenities
- 2 levels for proper linen
- 1 linen bag (70 liters)
- 1 steering handle
- Grey non marking wrap around bumper
- 2 fixed and 2 swivelling wheels Ø160 mm with polyamide layer

Options

- See page 18 - 19
- Thermobox 10 liters
- Chemicals basket
- Linen and/or waste bag holder and raising base



Saturne

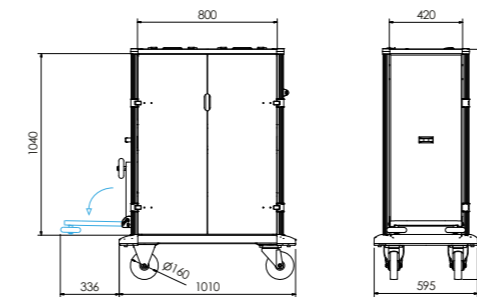

SATURNE

Overall dimensions				Reference *
Width (mm)	Depth (mm)	Height (mm)	Wheels Ø (mm)	Base Model
1010	595	1320	160	102001xx
Inside dimensions				
Width (mm)	Depth (mm)			
800	420			



TRADITIONAL RANGE

Corellia

Corellia mono

Auxiliary trolley for different purposes

Standard equipment

- Frame in anodised aluminium
- 4 drawers depth 120 mm and 2 drawers depth 170 mm
- 4 levels for ranging clean linen
- Steering handle
- Non marking grey wrap around bumper
- 2 swivelling and 2 fixed wheels
Ø160 mm with polyamide layer

Options

- Reclining bag holders and raising base (linen and/of garbage)
- Curtain for bag holder
- Mop holder
- Dividers for drawers
- Additional corner pads

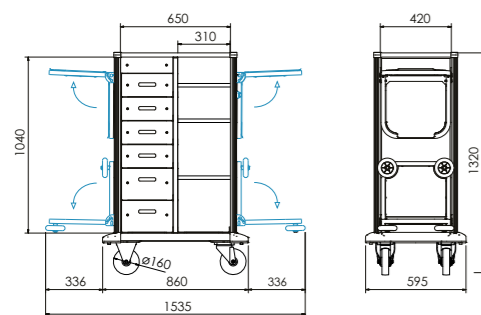

CORELLIA MONO

Length	Width (mm)	Height (mm)	Reference
860	595	1320	101902XX



Corellia duo

Auxiliary trolley for different purposes

Standard equipment

- Frame in anodised aluminium
- 8 drawers depth 120 mm and 4 drawers depth 170 mm
- Steering handle
- Non marking grey wrap around bumper
- 2 swivelling and 2 fixed wheels
Ø160 mm with polyamide layer

Options

- Reclining bag holders and raising base (linen and/of garbage)
- Curtain for bag holder
- Mop holder
- Dividers for drawers
- Additional corner pads

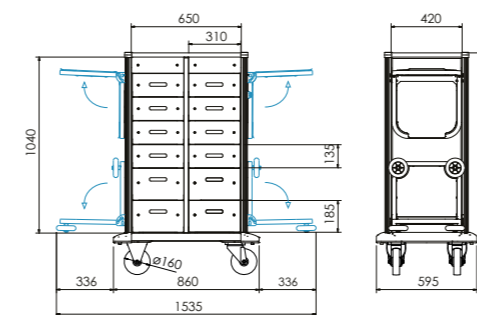

CORELLIA DUO

Length	Width (mm)	Height (mm)	Reference
860	595	1320	101901XX



TRADITIONAL RANGE

Hermia

Collection of soiled linen and/or garbage

Used separately or coupled with Atlas

Standard equipment

- Anodised aluminium frame
- Compartment for soiled linen with door and lid including a 100l bag
- A 40l drawer for chemicals, garbage, ...
- 4 swivelling wheels Ø125mm with non-marking thermoplastic layer
- 4 swivelling corner pads for protection
- A choice amongst different finishes (light grey, wenge oak look, black caviar look, almond look)

Options

- Coupling hook with Atlas

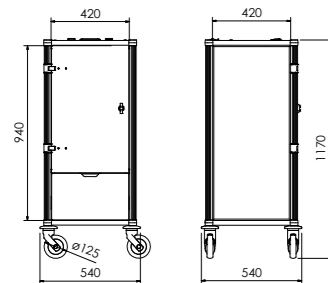

HERMIA

Width (mm)	Depth (mm)	Height (mm)	Wheels Ø (mm)	Base Model
540	540	1170	125	101501xx



FINISHES

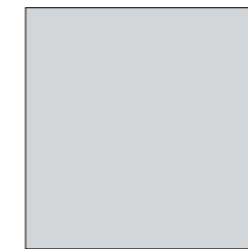

Light grey
Ref xx=09



Almond look
Ref xx=17



Wenge oak look
Ref xx=11

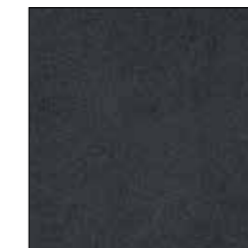

Black caviar look
Ref xx=14



BAG HOLDERS

Callisto

Linen bag holder used separately or coupled with Atlas

Capacity: 160L

Standard equipment

- Anodised aluminium frame
- 2 models; mono and duo
- 4 swivelling wheels Ø125mm with non-marking thermoplastic layer
- 4 swivelling corner pads for protection

Options

- Linen bags 160l in polyester resistant to high temperature washing in different colors: light grey, light brown, black
- Coupling hook with Atlas
- Ergonomic linen bag with vertical zipper

Callisto

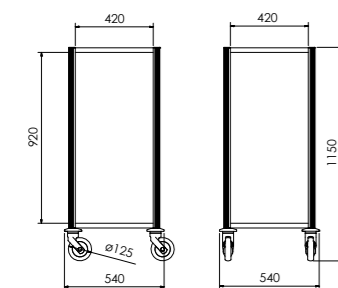

Callisto Duo

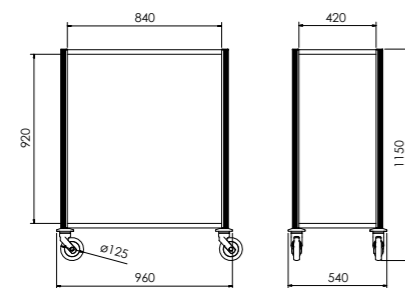

CALLISTO

	Width (mm)	Depth (mm)	Height (mm)	Wheels Ø (mm)	Reference
Callisto Mono	540	540	1150	125	11130100
Callisto Duo	540	960	1150	125	11130200



Callisto X

Standard equipment

- Foldable bag holder in anodised aluminium
- 4 swivelling wheels Ø125 mm with thermoplastic layer including 2 with brakes
- 4 corner pads

Options

- Linen bags 160 L (light grey, light brown, black)

Callisto X

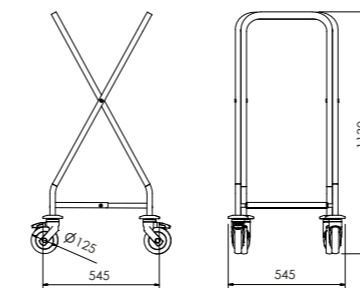

CALLISTO X

	Width (mm)	Depth (mm)	Height (mm)	Wheels Ø (mm)	Reference
Callisto X	545	545	1130	125	11130400



BAG HOLDERS

Protea

Transport of soiled linen and /
or garbage

Bag is closed with nylon halyard and fix-lock.

Standard equipment

- Anodised aluminium frame
- 4 models; mono, duo, trio, quattro
- For bags with a content of 80 or 110l
- Sac is fixed to trolley with a chromed steel ring
- For use with any type or format bag (minimum circumference 117cm)
- 4 swivelling wheels Ø75mm with non-marking thermoplastic layer
- 4 swivelling corner pads for protection

Options

- Lid
- Pedal and lid including soft close
- Linen bags 80l in polyester resistant to high temperature washing in different colors: sand, blue, red, green, yellow



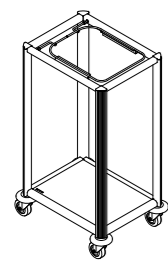

PROTEA 80 MONO

Reference *		
Base Model	With lid	With lid and pedal
11010100	11010200	11010300
Dimensions		
Width (mm)	Depth (mm)	Height (mm)
420	525	870

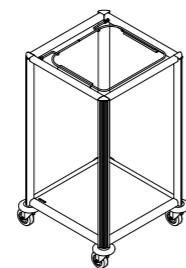

PROTEA 110 MONO

Reference *		
Base Model	With lid	With lid and pedal
11060100	11060200	11060300
Dimensions		
Width (mm)	Depth (mm)	Height (mm)
525	525	870

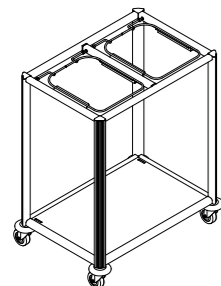

PROTEA 80 DUO

Reference *		
Base Model	With lid	With lid and pedal
11020100	11020200	11020300
Dimensions		
Width (mm)	Depth (mm)	Height (mm)
750	525	870

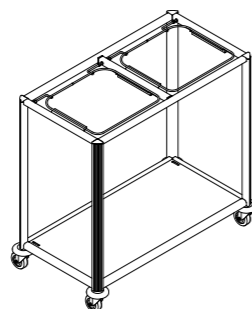

PROTEA 110 DUO

Reference *		
Base Model	With lid	With lid and pedal
11070100	11070200	11070300
Dimensions		
Width (mm)	Depth (mm)	Height (mm)
960	525	870

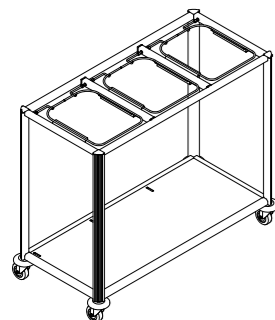

PROTEA 80 TRIO

Reference *		
Base Model	With lid	With lid and pedal
11030100	11030200	11030300
Dimensions		
Width (mm)	Depth (mm)	Height (mm)
1075	525	870

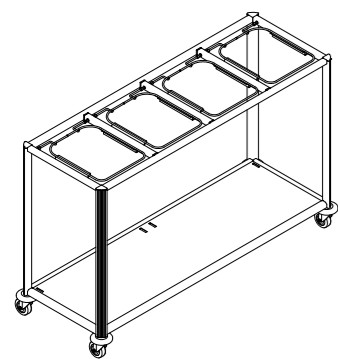

PROTEA 80 QUATTRO L

Reference *		
Base Model	With lid	With lid and pedal
11040100	11040200	11040300
Dimensions		
Width (mm)	Depth (mm)	Height (mm)
1400	525	870



BAG HOLDERS

Mars 400-800

At ease in the corridors,
just like in a Spa!

Standard equipment

- Anodised aluminium frame
- 2 models; Mars 400 and 800 (volume respectively 150 and 300l)
- 4 swivelling wheels Ø125mm with non-marking thermoplastic layer
- 4 swivelling corner pads for protection

Options

- Linen bags 150 or 300l in polyester resistant to high temperature washing in different colors.
- Colors : light grey, light brown, black
- Partitions (Mars 800 only)
- Lid (Mars 800 only)

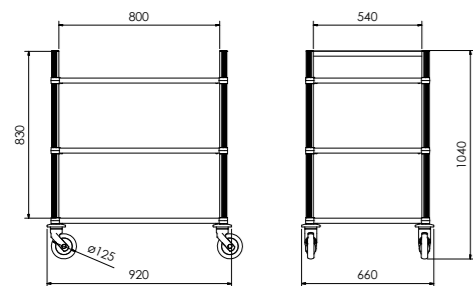

MARS 800

Width (mm)	Depth (mm)	Height (mm)	Wheels Ø (mm)	Base Model
920	660	1040	125	11140100

MARS 400

Width (mm)	Depth (mm)	Height (mm)	Wheels Ø (mm)	Base Model
660	520	1040	125	11140200

FINISHES

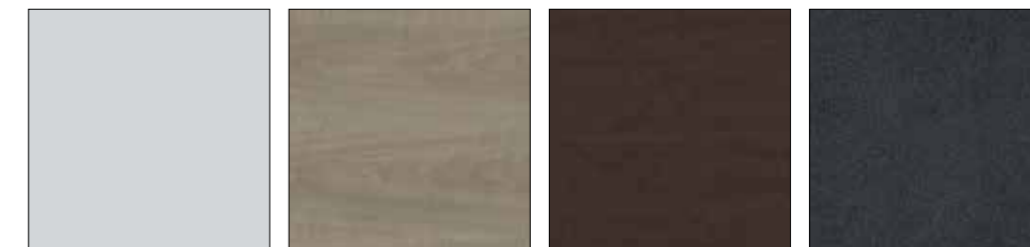

Light grey
Ref xx=09

Almond look
Ref xx=17

Wenge oak look
Ref xx=11

Black caviar look
Ref xx=14

LINEN BAG COLORS

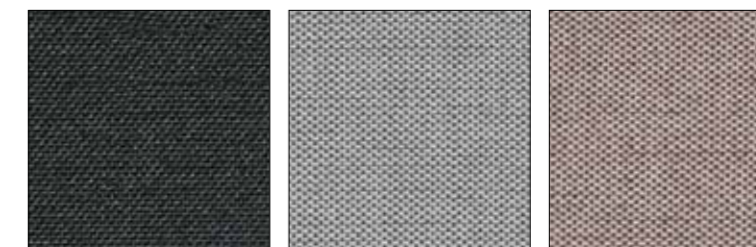

Black

Grey

Brown



HOUSEKEEPING



La Malle

EXCLUSIVE RANGE

Meet the great travellers of the early 20th century whilst Ascolia makes you rediscover the trunk concept and its symbolism.

Thanks to its compact dimensions La malle is easily taken into the room, leaving corridors free and therefore enabling room service with closed doors.

Do not be afraid to leave it in your corridors; passers-by will be delighted by its 5 star aesthetics.

Its manoeuvrability and ergonomics make it the ideal companion for your chamber maids.

EXCLUSIVE RANGE

Gulliver 800

When room-service happens unnoticed in the traveller's eyes...

Capacity: 2 to 3 rooms

Standard equipment

- Anodised aluminium frame
- 1 compartment for soiled linen including a 70l bag
- 2 compartments for garbage (14l) including 2 removable bins
- 2 levels for ranging clean linen
- 1 compartment for chemicals with 2 removable boxes
- 1 drawer for amenities, courtesy trays, stationery,...
- 2 doors (opening up to 270°)
- A4 stationery compartment (inside door)
- 1 horizontal steering handle
- 4 swivelling wheels Ø125mm with non-marking polyamide layer
- 4 swivelling corner pads for protection

Options

- Partitioning for amenities drawer
- Mop holder and hook
- Broom holder or vacuum cleaner hose holder
- Sliding tray for vacuum cleaner
- Crowbar
- Motorisation, see page 42-43



Gulliver 650

When room-service happens unnoticed in the traveller's eyes...

Capacity: 2 to 3 rooms

Standard equipment

- Anodised aluminium frame
- 1 drawer for amenities
- 3 levels for ranging clean linen
- 1 removable box for chemicals
- 2 doors (opening up to 270°)
- 1 horizontal steering handle
- 4 swivelling wheels Ø125mm with non-marking polyamide layer
- 4 swivelling corner pads for protection
- A choice amongst different finishes (wenge oak look, black caviar look, brown buffalo look, almond look)
- Compartments for stationery at inside doors

Options

- Linear dividers or partitioning for amenities drawer
- Mop holder and hook
- Sliding tray for vacuum cleaner



Gulliver 800 and 650

EXCLUSIVE RANGE

Gulliver 800

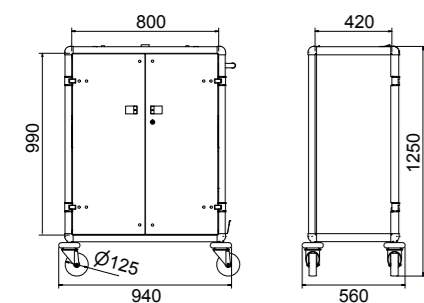

GULLIVER 800

Overall dimensions				Reference *
Width (mm)	Depth (mm)	Height (mm)	Wheels Ø (mm)	Base Model
940	560	1255	125	101302xx
Inside dimensions				
Width (mm)	Depth (mm)			
690	420			



Motorisation
(Gulliver 800 only)

Gulliver 650

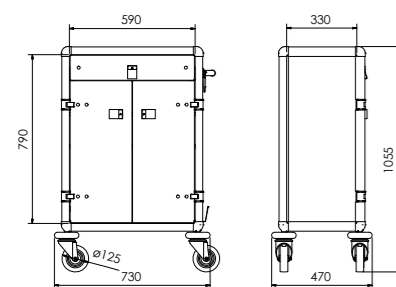

GULLIVER 650

Overall dimensions				Reference *
Width (mm)	Depth (mm)	Height (mm)	Wheels Ø (mm)	Base Model
730	470	1055	125	101603XX
Inside dimensions				
Width (mm)	Depth (mm)			
590	330			



STANDARD EQUIPMENT



Compartment for chemicals



Handles on doors and lids with leather finish



Compartment for garbage and linen



A4 stationery compartment



Drawer for amenities and stationery

OPTIONS



Mop holder and hook



Sliding tray for vacuum cleaner



Motorisation
(Gulliver 800 only)

FINISHES



Brown buffalo look
Ref xx=16

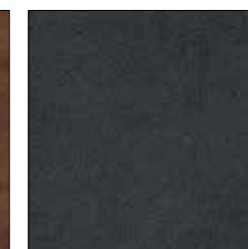

Black caviar look
Ref xx=14



Aspect wengé
Ref xx=11

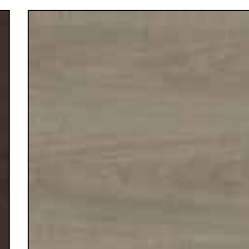

Almond look
Ref xx=17

EXCLUSIVE RANGE

Despina

650 and 800

La malle in traditional version

Capacity: 4 to 6 rooms

Standard equipment

- Anodised aluminium frame
- 2 models; Despina 800 and 650
- Compartment for amenities with lid
- 3 levels for ranging clean linen
- 2 doors (opening up to 270°)
- 1 horizontal steering handle
- 4 swivelling wheels Ø125mm with non-marking polyamide layer
- 4 swivelling corner pads for protection
- A choice amongst different finishes (wenge oak look, black caviar look, brown buffalo look, almond look)

Options

- Linear dividers or partitioning for amenities compartment
- Drawers
 - Amenities drawer
 - Linear dividers
 - Partitioning
- Stationery drawer, including linear dividers
- Lock on doors
- Lock on lid
- Accessories
 - Mop holder and hook
 - Broom holder or vacuum cleaner hose holder
- Sliding tray for vacuum cleaner
- Crowbar
- Motorisation (Despina 800 only), see pages 46-47



DESPINA 650

E-DESPINA 800
"BLACK EDITION" (optional)

Despina 650

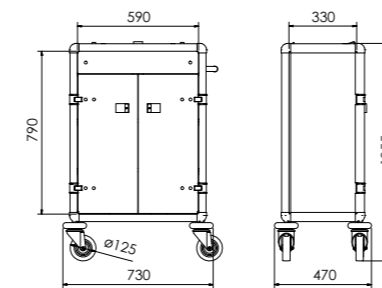

Overall dimensions				Reference *
Width (mm)	Depth (mm)	Height (mm)	Wheels Ø (mm)	Base Model
730	470	1055	125	101602xx
Inside dimensions				
Width (mm)	Depth (mm)			
590	330			

Despina 800

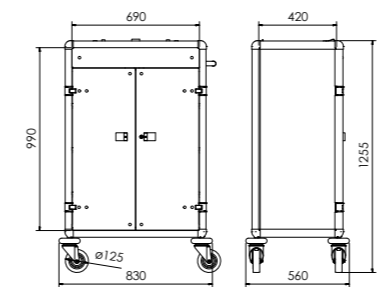

Overall dimensions				Reference *
Width (mm)	Depth (mm)	Height (mm)	Wheels Ø (mm)	Base Model
830	560	1255	125	101601xx
Inside dimensions				
Width (mm)	Depth (mm)			
690	420			

OPTIONS



Amenities and/or stationery drawer



Sliding tray for vacuum cleaner



Mop holder and hook



Motorisation (Despina 800 only)

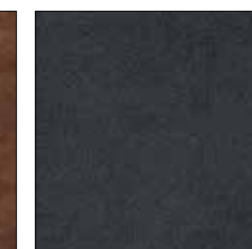
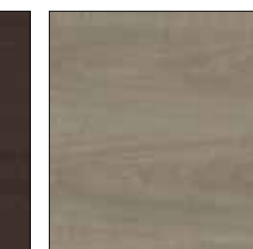

FINISHES

Brown buffalo look
Ref xx=16Black caviar look
Ref xx=14Aspect wengé
Ref xx=11Almond look
Ref xx=17



MOTORISATION

GULLIVER 800 and
DESPINA 800

ASCOLIA WHEELS YOUR TROLLEY!

LESS EFFORT, MORE JOY

The ergonomic controller allows
you an easy and intuitive use

Characteristics

- Progressive and silent acceleration
- Safety of use
- Great manoeuvrability
- Pivots on the spot
- Charging time: 7 hours
- CE certification

Technical specifications

- Power : 240 W
- Maximum forward speed : 5 km/h
- Maximum reverse speed : 3 km/h



EXCLUSIVE RANGE

Cortes

Collection of soiled linen and garbage, in addition to Despina

Standard equipment

- Anodised aluminium frame
- 1 compartment for soiled linen with bag 100l and lid
- 1 compartment for garbage bag with lid
- 2 drawers 20l each for chemicals, stationery, ...
- 2 doors (opening up to 270°)
- 1 horizontal steering handle
- 4 swivelling wheels Ø125mm with non-marking polyamide layer
- 4 swivelling corner pads for protection
- A choice amongst different finishes (wenge oak look, black caviar look, brown buffalo look, almond look)

Options

- Broom holder or vacuum cleaner hose holder
- Sliding tray for vacuum cleaner

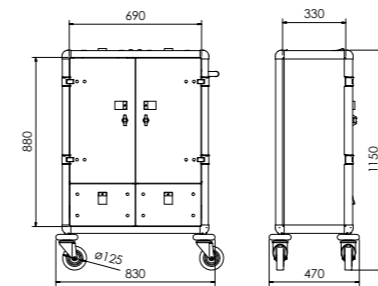

CORTES

Overall dimensions				Reference *	
Width (mm)	Depth (mm)	Height (mm)	Wheels Ø (mm)	Base Model	
830	470	1150	125	112101xx	
Inside dimensions					
Width (mm)	Depth (mm)				
690	330				

FINISHES

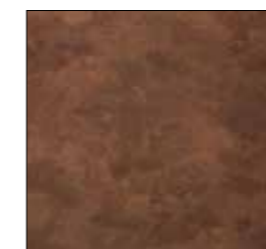

Brown buffalo look
Ref xx=16

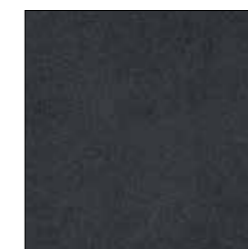

Black caviar look
Ref xx=14

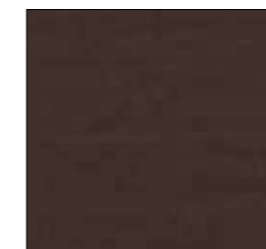

Wenge oak look
Ref xx=11



Almond look
Ref xx=17



SATELLITE OF "LA MALLE"

Magellan

La malle with limited dimensions makes it can be taken into the room

Standard equipment

- Anodised aluminium frame
- 1 compartment for soiled linen with bag 100l, lid and door
- 1 drawer 40l for chemicals, stationery, ...
- 4 swivelling wheels Ø125mm with non-marking polyamide layer
- 4 swivelling corner pads for protection
- A choice amongst different finishes (wenge oak look, black caviar look, brown buffalo look, almond look)
- 1 horizontal steering handle

Option

- Coupling hook with Despina
- Sliding tray in linen compartment



FINISHES



Brown buffalo look
Ref xx=16

Black caviar look
Ref xx=14



Wenge oak look
Ref xx=11

Almond look
Ref xx=17



MAGELLAN
"BLACK EDITION" (optional)

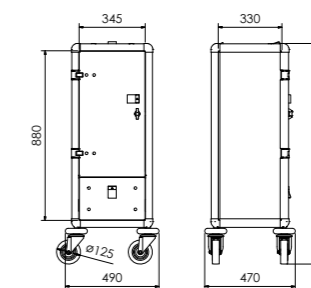

MAGELLAN

Overall dimensions				Reference *
Width (mm)	Depth (mm)	Height (mm)	WheelsØ (mm)	Base Model
490	470	1150	125	111801xx
Inside dimensions				
Width (mm)	Depth (mm)			
345	330			

SMALL CORRIDORS RANGE

Pluton

Housekeeping trolley for small corridors

Capacity: 3 to 4 rooms

Standard equipment

- Anodised aluminium frame
- 2 models: Pluton 520 and 650
- 1 open compartment for amenities
- 3 levels for ranging clean linen
- 1 horizontal steering handle
- 4 swivelling wheels Ø125mm with non-marking thermoplastic layer
- 4 swivelling corner pads for protection
- A choice amongst different finishes (light grey, wenge oak look, black caviar look, almond look)

Options

- Waste bag holder mono and foldable base
 - Waste bag curtain
- Linen bag holder and foldable base
 - Linen bag 100 liters light grey, light brown or black
- Amenities compartment
 - Linear dividers
 - Partitioning



Pluton 520

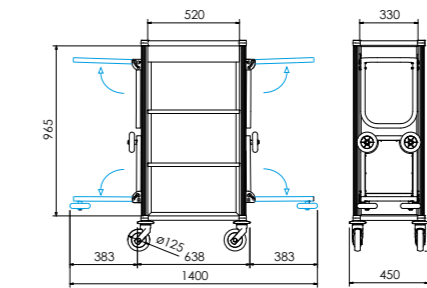

Pluton 650

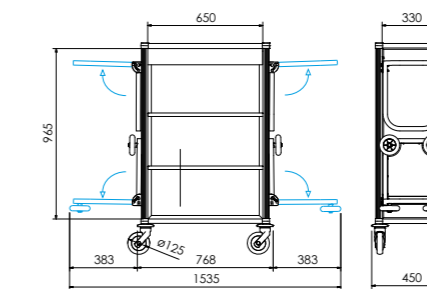

PLUTON 520

Overall dimensions				Reference *
Width (mm)	Depth (mm)	Height (mm)	Wheels Ø (mm)	Base Model
638	450	1195	125	100802xx
Inside dimensions				
Width (mm)	Depth (mm)			
520	330			

PLUTON 650

Overall dimensions				Reference *
Width (mm)	Depth (mm)	Height (mm)	Wheels Ø (mm)	Base Model
768	450	1195	125	100801xx
Inside dimensions				
Width (mm)	Depth (mm)			
650	330			

FINISHES

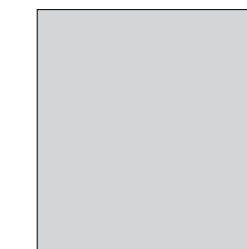
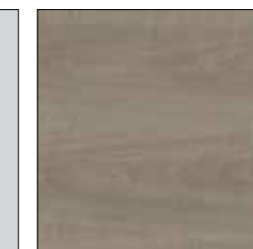
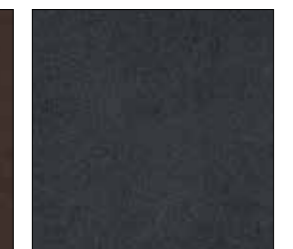
Light grey
Ref xx=09Almond look
Ref xx=17Wenge oak look
Ref xx=11Black caviar look
Ref xx=14

SMALL CORRIDORS RANGE

Vega

Limited size

Capacity: 3 to 4 rooms

Standard equipment

- Anodised aluminium frame
- 3 levels for ranging clean linen
- Partitions
- 4 swivelling wheels Ø125mm with non-marking thermoplastic layer
- 4 swivelling corner pads for protection
- A choice amongst different finishes (light grey, wenge oak look, black caviar look, almond look)

Options

- Waste bag holder mono and foldable base
 - Selective waste sorting; waste bag holder duplo
 - Waste bag curtain
- Linen bag holder and foldable base
 - Linen bag 100l light grey, light brown or black
 - Lid for linen bag holder
- Removable tray for amenities 60 or 120mm
- Drawers
 - Amenities drawer
 - Linear dividers
 - Partitioning
 - Stationery drawer including linear dividers
- Doors (opening up to 270°)
- Coupling hook for bag holder Protea 80 Duo
- Horizontal steering handle



Vega

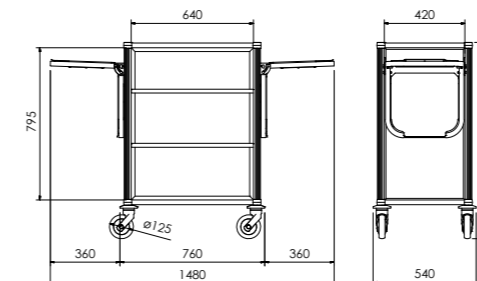

VEGA

Overall dimensions				Reference *
Width (mm)	Depth (mm)	Height (mm)	Wheels Ø (mm)	Base Model
760	540	1025	125	100401xx
Inside dimensions				
Width (mm)	Depth (mm)			
620	420			

OPTIONS



Removable tray for amenities 60 or 120mm



Stationery drawer including linear dividers



Amenities drawer



Linear dividers for drawers



Waste bag holder



Doors

FINISHES

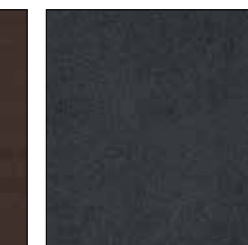
Light grey
Ref xx=09Almond look
Ref xx=17Wenge oak look
Ref xx=11Black caviar look
Ref xx=14

SMALL CORRIDORS RANGE

Minos

Intended for small lifts, for overcoming small steps, ...

Capacity: 3 to 5 rooms

Standard equipment

- Anodised aluminium frame
- 1 open compartment for amenities
- 3 levels for ranging clean linen
- 1 foldable linen bag holder
- 1 horizontal steering handle
- Wheels
 - Minos 125 - 4 swivelling wheels Ø125mm with non-marking thermoplastic layer
 - Minos 300 - 2 swivelling wheels Ø125mm with non-marking thermoplastic layer and 2 fixed wheels Ø 300mm with polyurethane layer to allow to overcome small steps
- 4 swivelling corner pads for protection
- A choice amongst different finishes (light grey, wenge oak look, black caviar look, almond look)
- 1 open compartment at the bottom (chemicals,...)

Options

- 1 door (opening up to 270°)
- Lid on amenities compartment



Minos 125

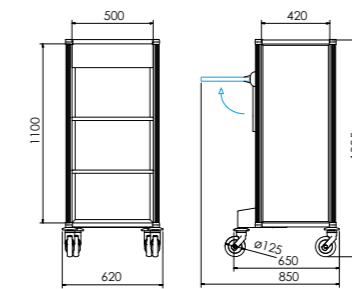

Minos 300

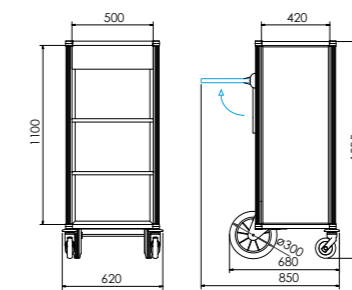

FINISHES

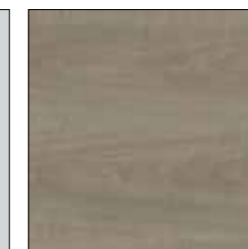
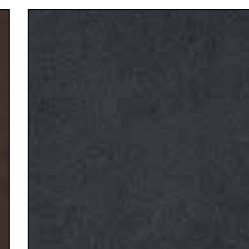
Light grey
Ref xx=09Almond look
Ref xx=17Wenge oak look
Ref xx=11Black caviar look
Ref xx=14

MINOS 125

Overall dimensions				Reference *
Width (mm)	Depth (mm)	Height (mm)	WheelsØ (mm)	Base Model
620	650	1335	125	100701xx
Inside dimensions				
Width (mm)	Depth (mm)			
500	420			

MINOS 300

Overall dimensions				Reference *
Width (mm)	Depth (mm)	Height (mm)	WheelsØ (mm)	Base Model
620	680	1335	125/300	100702xx
Inside dimensions				
Width (mm)	Depth (mm)			
500	420			

TRANSPORT, STORAGE AND DISTRIBUTION OF CLEAN LINEN

Antares

Distribution and/or storage of clean linen

Standard equipment

- Anodised aluminium frame
- 2 models; Antares 850 and 1250
- 3, 4 or 5 levels for ranging clean linen
- 4 swivelling wheels Ø125mm with non-marking thermoplastic layer
- 4 swivelling corner pads for protection
- Lock without key

Options

- Horizontal steering handle
- Partitions
- Doors
- Lock with key

ANTARES 850

Number of storage levels	Depth (mm)	Width (mm)	Height (mm)	Distance between shelves	Classic model	Partitions	Partitions & doors
3	660	940	1585	435	20010100	20010700	20011300
4	660	940	1585	325	20010200	20010800	20011400
5	660	940	1585	250	20010300	20010900	20011500

ANTARES 1250

Number of storage levels	Depth (mm)	Width (mm)	Height (mm)	Distance between shelves	Classic model	Partitions	Partitions & doors
3	660	1340	1585	435	20010400	20011000	20011600
4	660	1340	1585	325	20010500	20011100	20011700
5	660	1340	1585	250	20010600	20011200	20011800



Metis

Distribution and/or storage of clean linen

Standard equipment

- Modular shelving system in chromed steel
- 5 models for great modularity; Metis 610, 912, 1217, 1520 and 1826
- 4 or 5 levels for ranging clean linen
- 4 swivelling wheels Ø125mm with non-marking thermoplastic layer, of which 2 with brake
- 4 swivelling corner pads for protection
- Material delivered flat packed ready to assemble

Options

- Horizontal steering handle
- Label holder
- Lateral and dorsal retaining rods with clips
- Dividers
- Clothes hanger
- Protective cover

	Width (mm)	Depth (mm)	Height (mm)	Number of shelves	Reference
Metis 610	610	460	1800	5	20031100
Metis 610	610	460	1800	6	20031600
Metis 912	912	460	1800	5	20031200
Metis 912	912	460	1800	6	20031700
Metis 1217	1217	460	1800	5	20031300
Metis 1217	1217	460	1800	6	20031800
Metis 1520	1520	460	1800	5	20031400
Metis 1520	1520	460	1800	6	20031900



COLLECTION OF SOILED LINEN

Missouri



Model 690 / 1050



Model 350

Standard equipment

- Anodised aluminium container
- 3 models: Missouri 350, 690 and 1050
- Lid and front foldable
- 2 fixed and 2 swivelling wheels Ø200mm (models 690 and 1050), Ø125mm (model 350)
- Wrap-around bumper for protection
- Horizontal steering handle
- Drainage channel and drain valve in trolley base

	Length (mm)	Width (mm)	Height (mm)	Wheels Ø (mm)	VOLUME (L)	Reference
Missouri 350	950	550	980	125	350	74010300
Missouri 690	1140	690	1490	200	690	74010100
Missouri 1050	1390	810	1490	200	1050	74010200



Model 690 / 1050

Messipi

Spring loaded trolley;
stop the back pain!

Standard equipment

- Anodised aluminium container
- 4 models: Messipi 195, 280, 315 or 570
- Vertically moveable base to keep load at constant height for easy access
- 2 swivelling and 2 fixed wheels Ø125mm with non-marking rubber layer, arranged centrally

	Overall dimensions (mm)	Inside dimensions (mm)	Volume (L)	Reference
Messipi 195	1060 x 470 x 800	1010 x 420 x 460	195	74020900
Messipi 280	1060 x 650 x 800	1010 x 600 x 460	280	74021000
Messipi 315	1060 x 710 x 820	1000 x 650 x 485	315	74021100
Messipi 570	1460 x 750 x 920	1410 x 700 x 580	570	74021200



COLLECTION OF SOILED LINEN

Sirius

Multipurpose
polyethylene trolley

Standard equipment

- Polyethylene tank
- 2 models: Sirius 145 and 305
- 4 swivelling wheels Ø75 (Sirius 145) or 125mm (Sirius 305)

Option

- Lid



SIRIUS

	Overall dimensions (mm)	Inside dimensions (mm)	Reference
Sirius 145	800 x 450 x 685	660 x 310 x 584	74050200
Sirius 305	990 x 686 x 762	902 x 597 x 622	74050300

Felucia

Multipurpose steel trolley

Standard equipment

- Wired steel trolley
- Volume : 300 liters
- 4 non marking polyamide swivelling wheels Ø100 mm



FELUCIA

Width (mm)	Depth (mm)	Height (mm)	Reference
860	660	725	11200100

CONTAINER TROLLEYS

Leda

High wired container for linen transport

Standard equipment

- Galvanised steel container
- 2 partial doors (opening up to 270°)
- Lateral and back partitions
- 1 removable shelf
- 4 swivelling wheels Ø125mm with non-marking polyamide layer

Options

- Grey cover with PU coating

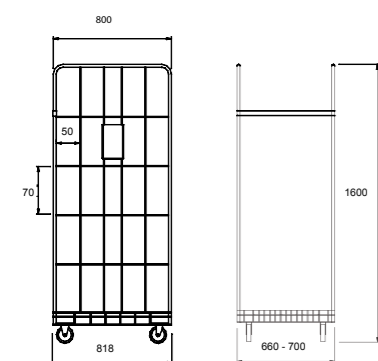

Length	Width (mm)	Height (mm)	Reference
818	660	1600	7404100



MAINTENANCE

Lavezzi

The companion of the maintenance service

Standard equipment

- Anodised aluminium frame
- 1 compartment including 3 baskets with height 100mm and 1 basket with height 200mm for ranging amenities, bottles, chemicals, ...
- 1 platform for vacuum cleaner, mop or box
- 4 swivelling wheels Ø125mm with non-marking thermoplastic layer
- 4 swivelling corner pads for protection
- A choice amongst different finishes (light grey, wenge oak look, black caviar look, almond look)

Options

- Shutter for open compartment
- Waste bag holder mono and foldable base
- Broom holder
- Vacuum cleaner hose holder

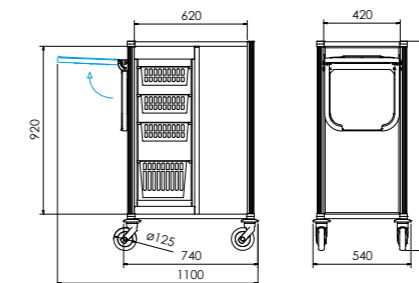

FINISHES

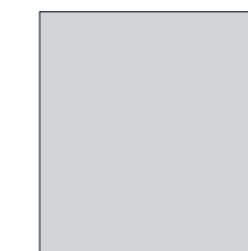

Light grey
Ref xx=09



Almond look
Ref xx=17



Wenge oak look
Ref xx=11

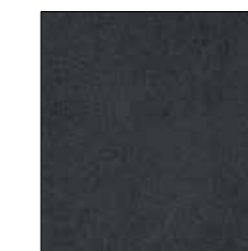

Black caviar look
Ref xx=14

Overall dimensions			
Width (mm)	Depth (mm)	Height (mm)	Wheels Ø (mm)
740	540	1150	125
Inside dimensions			
Width (mm)	Depth (mm)		
620	420		

HOUSEKEEPING COMPLEMENTS

Daphnis

Dislodgement trolley

Standard equipment

- Anodised aluminium frame
- 3 levels for ranging clean linen
- 1 base with carpet
- 1 integrated clothes hanger
- 4 swivelling wheels Ø125mm with non-marking thermoplastic layer
- 4 swivelling corner pads for protection
- A choice amongst different carpet colors (blue, red, brown, black)

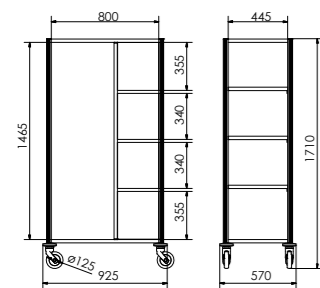

Width (mm)	Depth (mm)	Height (mm)	Wheels Ø (mm)	Classical M
925	570	1710	125	100901xx



CARPET



Blue Ref (xx)=40



Red Ref (xx)=41

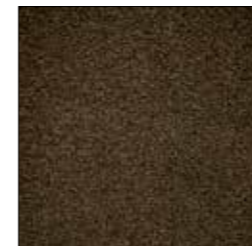

Brown Ref (xx)=43



Black Ref (xx)=42

Vesta

Mobile wardrobe

Standard equipment

- Anodised aluminium frame
- 1 large integrated clothes hanger
- 4 swivelling wheels Ø125mm with non-marking thermoplastic layer of which 2 with brake
- 4 swivelling corner pads for protection

Options

- Hat rack

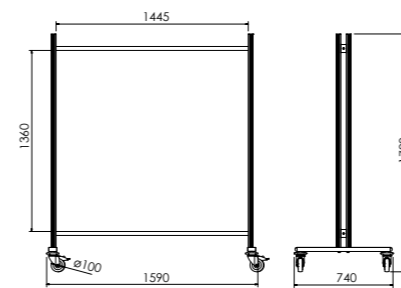

Base (mm)	Height (mm)	Wheels Ø (mm)	Reference
1590x740	1790	125	18010100





ROOM SERVICE AND CATERING

Functionality, hygiene and easy maintenance are essential for your food- and drink distribution material.

Lightness, manoeuvrability and ergonomics will contribute to the well-being of the user, the aesthetics will delight the client!

By listening to you, Ascolia has developed a range of mobile furniture for the room service and catering departments.

TRADITIONAL RANGE

Balaton Minibar restocking

Standard equipment

- Anodised aluminium frame
- 2 models; Balaton 520 and 800
- 1 open compartment for small products
- 3 interior possibilities :
 - 3 fixed shelves with retaining bars
 - 3 sliding trays
 - 3 drawers (depth 100mm) on telescopic rails, height adjustable
- Lockable shutter
- Wheels :
 - Balaton 520 – 4 swivelling wheels Ø125mm with non-marking thermoplastic layer
 - Balaton 800 – 2 fixed and 2 swivelling wheels Ø160mm with non-marking polyamide layer
- Grey wrap-around non-marking bumper
- Horizontal steering handle
- A choice amongst different finishes (light grey, wenge oak look, black caviar look, almond look)

Also available with lockable doors instead of shutter.

Options

- Lockable shutter including RFID lock
- Small products compartment
 - Linear dividers
 - Partitioning
 - Lid with or without lock
- Drawers
 - Linear dividers
 - Partitioning
 - Non-slip carpet
- Accessories
 - Stackable water tight box for tableware
 - 15 or 30l lateral container (bacbis)
- Extra protection via additional swivelling corner pads
- Motorisation, see page 73



Balaton 520

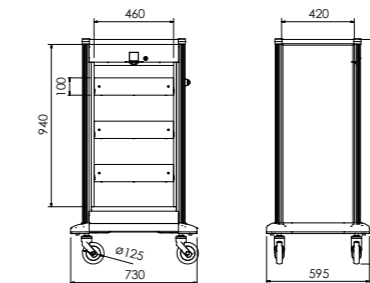

BALATON 520

Overall dimensions				Reference*	
Width (mm)	Depth (mm)	Height (mm)	Wheels Ø (mm)	with shelves	with 3 drawers
730	595	1300	125	170105xx	170107xx
Inside dimensions					
Width (mm)	Depth (mm)				
460	420				

Balaton 800

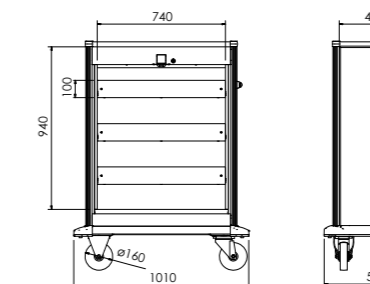

BALATON 800

Overall dimensions				Reference *	
Width (mm)	Depth (mm)	Height (mm)	Wheels Ø (mm)	with shelves	with 3 drawers
1010	595	1320	160	170209xx	170211xx
Inside dimensions					
Width (mm)	Depth (mm)				
740	420				

FINISHES

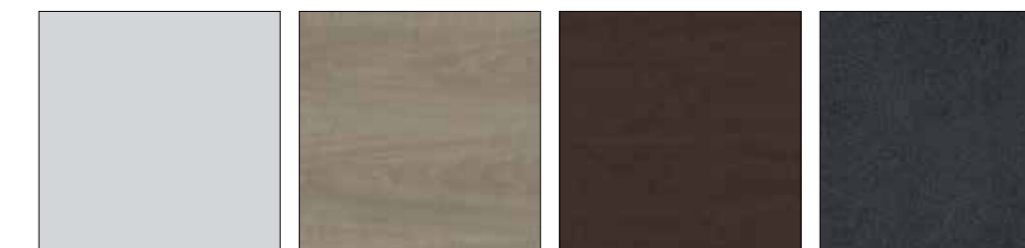

Light grey
Ref xx=09

Almond look
Ref xx=17

Wenge oak look
Ref xx=11

Black caviar look
Ref xx=14

EXCLUSIVE RANGE "LA MALLE"

Lugano Minibar restocking

"La malle" in minibar restocking version

Standard equipment

- Anodised aluminium frame
- 2 models; Lugano 650 and 800
- 1 compartment for small products with lid
- 2 interior possibilities :
 - Lugano 800 - 3 drawers (depth 100mm) on telescopic rails, height adjustable
 - Lugano 650 - 2 fixed shelves with retaining bars
- Doors (opening up to 270°) with lock
- 4 swivelling wheels Ø125mm with non-marking polyamide layer
- 4 swivelling corner pads for protection
- 1 horizontal steering handle
- A choice amongst different finishes (wenge oak look, black caviar look, brown buffalo look, almond look)

Options

- Small products compartment
 - Linear dividers
 - Partitioning
- Drawers
 - Linear dividers
 - Partitioning
 - Non-slip carpet
- 5" steering wheel coupled with 4 swivelling wheels (Lugano 800 only)
- Motorisation, see page 73



FINISHES



Brown buffalo look
Ref xx=16

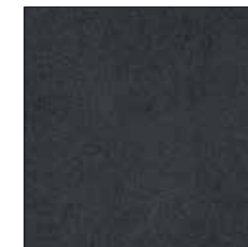

Black caviar look
Ref xx=14



Almond look
Ref xx=17



Wenge oak look
Ref xx=11

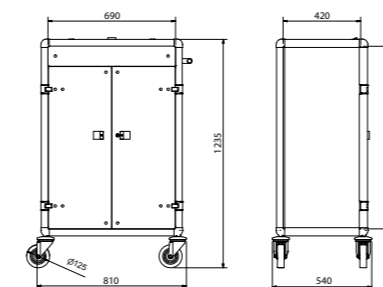

Overall dimensions				Reference *
Width (mm)	Depth (mm)	Height (mm)	Wheels Ø (mm)	Base Model
810	540	1235	125	170501xx
Inside dimensions				
Width (mm)	Depth (mm)			
690	420			

MOTORISATION Balaton and Lugano



BANQUETING TROLLEY

Manta

Standard equipment

- Anodised aluminium frame
- Open compartment at top for amenities: tea bags, nespresso cups, milk, sugar, cookies...
- Amenities and stationery drawer
- Steering handle
- 1 compartment for plates, glasses,...
- 1 compartment for dishwasher baskets for glasses
- 1 compartment for water and soft-drink boxes
- 2 fixed and 2 swiveling wheels Ø160 mm with non-marking thermoplastic layer

Options

- Doors
- Garbage bag holder mono with lid and raising base with integrated corner pads
- Garbage bag holder duplo with lid and raising base with integrated corner pads
- Dividers for stationery drawer
- Additional steering handle
- 4 swiveling wheels Ø160 mm with non-marking thermoplastic layer combined with a 5th steering wheel

Finishes (xx)

- Light grey ref: 09
- Wengé look ref: 11
- Black caviar look ref: 14
- Almond look ref: 17



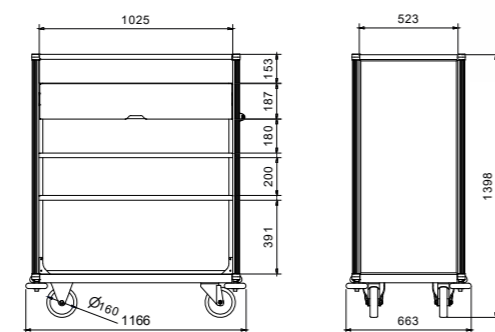

Overall dimensions				Reference
Height (mm)	Width (mm)	Depth (mm)	wheels Ø (mm)	
1398	1166	663	160	170801xx

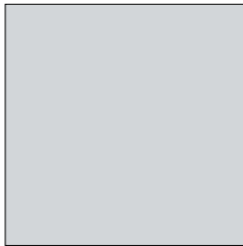

MOTORISATION

eManta

FINISHES

	
Light grey Ref xx=09	Black caviar look Ref xx=14
	
Wenge oak look Ref xx=11	Almond look Ref xx=17



ROOM SERVICE TABLE

Montebello

Room service table, the expected evolution !



Standard equipment

- Powder coated steel frame, wooden legs
- Wooden table surface with foldable sides (Ø 1 m)
- Easy storage (3 tables/m²)
- 4 swivelling wheels Ø 125 mm with non marking thermoplastic layer of which 2 with brake
- Material delivered flat packed ready to assemble

Options

- Solar hot box and Omega
- Fleece protection

Finishes

- Wenge or light oak

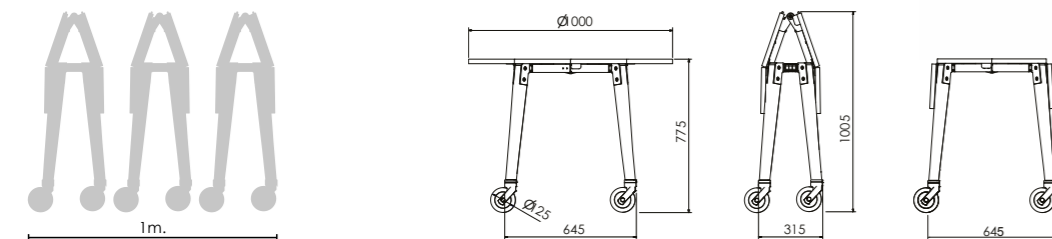

Overall dimensions			Reference *
WidthØ (mm)	Height (mm)	WheelsØ (mm)	
1000	775	125	170601xx

Omega

Ergonomic solution for transport of hot boxes

Standard equipment

- Foldable trolley
- 2 swivelling and 2 fixed wheels Ø 125 mm
- To be coupled with Montebello

Options

- Solar hot box

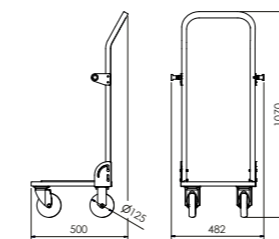

Overall dimensions				Reference *
Width (mm)	Depth (mm)	Height (mm)	WheelsØ (mm)	
482	500	1070	125	17070100

ROOM SERVICE TABLE

Lagoon

Standard equipment

- Anodised aluminium frame
- Lifting wooden surface with foldable sides (Ø 1m)
- Bases are nestable for space-saving storage
- 4 swivelling wheels Ø125mm with non-marking thermoplastic layer of which 2 with brake
- 4 swivelling corner pads for protection
- Material delivered flat packed ready to assemble

Options

- Solar hotbox with rails
- Fleece protection

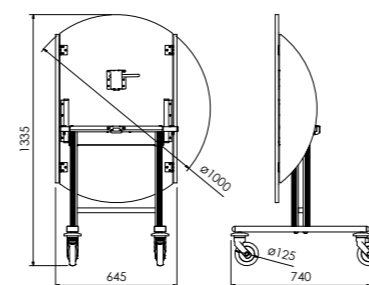

Ø (mm)	Height (mm)	Type	Wheels Ø (mm)	Reference
1000	750	swivelling	125	17030100

ROLLING TABLES

Michigan

The aesthetic rolling table

Standard equipment

- Anodised aluminium frame
- 2 or 3 removable shelves in compact panel for easy cleaning
- 4 swivelling wheels Ø125mm with non-marking thermoplastic layer
- 4 swivelling corner pads for protection
- A choice amongst different finishes (light grey, wenge oak look, black caviar look, almond look)

Options

- 15 or 30l lateral container (bacbis)
- Partitions
- Doors



Overall dimensions				Reference *
Width (mm)	Depth (mm)	Height (mm)	Wheels Ø (mm)	Base Model
920	660	1040	125	150201xx
Inside dimensions				
Width (mm)	Depth (mm)			
800	540			

FINISHES

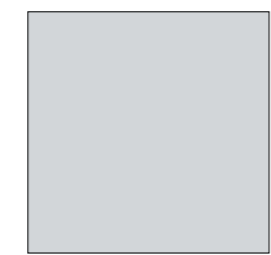
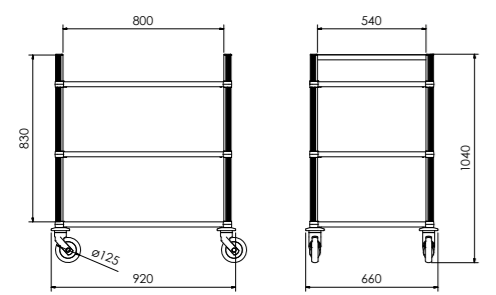

Light grey Ref xx=09



Almond look Ref xx=17



Wenge oak look Ref xx=11



Black caviar look Ref xx=14

Baringo

The full stainless steel!

Standard equipment

- Stainless steel frame
- 3 models: 700, 900 and 1100mm
- Noise minimising coating on lower side
- 2 or 3 levels
- 4 swivelling wheels Ø125mm with non-marking thermoplastic layer
- 4 swivelling corner pads for protection

Options

- Stainless steel container 21l
- Container 45l



	Width (mm)	Depth (mm)	Height (mm)	Wheels Ø (mm)	Distance between shelves (mm)	Reference
Baringo 642	700	500	950	125	585	74060100
Baringo 643	700	500	950	125	275	74060200
Baringo 852	900	600	950	125	585	74060300
Baringo 853	900	600	950	125	275	74060400
Baringo 1052	1100	600	950	125	585	74060500
Baringo 1053	1100	600	950	125	275	74060600



RACKING TROLLEYS

For a fast and efficient service;
the racking trolleys

Selection criteria

- The number of trays
- The distance between the slides depending on the height of your glasses, cups, ... (2 distances available 100 and 125mm)
- The type of normalised tray used : Gastronorm (325x530mm), or Euronorm (370 x 530 mm)
- Different widths available for multiple choices:
 - **Aral** : 1 column for ranging trays
 - **Baikal** : 2 columns for ranging trays
 - **Victoria** : 3 columns for ranging trays

Standard equipment

- Welded racking trolley in anodised aluminium
- Silence, durability and hygiene thanks to large welded rails
- Between 5 and 14 trays per column according to model chosen
- 3 standard heights available: 1255, 1455 and 1655mm
- 2 distances between slides available: 100 and 125mm
- 4 swivelling wheels Ø125mm with non-marking thermoplastic layer
- 4 swivelling corner pads for protection

Options

- Partitions plus doors
- Upper railing 150mm
- Lateral garbage bag holder
- Lateral foldable worksurface
- 15 or 30l lateral container (bacbis)
- Horizontal steering handle
- Compact panel top with 50mm edge
- Brake on 2 swivelling wheels

Aral



Baikal



Victoria



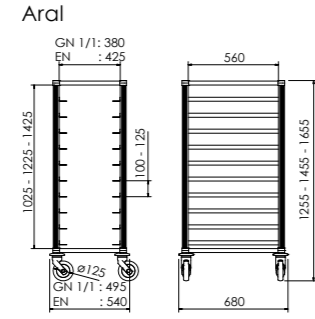

ARAL

Overall dimensions				
Height (mm)	Width (mm) GN/EN	Depth (mm)	Qty. of trays Distance between shell 100mm	Qty. of trays Distance between shell 125mm
1255	495/540	680	10	8
1455	495/540	680	12	9
1655	495/540	680	14	11

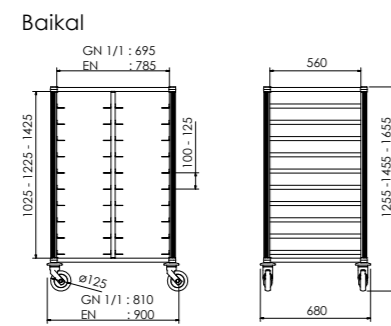

BAIKAL

Overall dimensions				
Height (mm)	Width (mm) GN/EN	Depth (mm)	Qty. of trays Distance between shell 100mm	Qty. of trays Distance between shell 125mm
1255	810/900	680	2X10	2X8
1455	810/900	680	2X12	2X9
1655	810/900	680	2X14	2X11

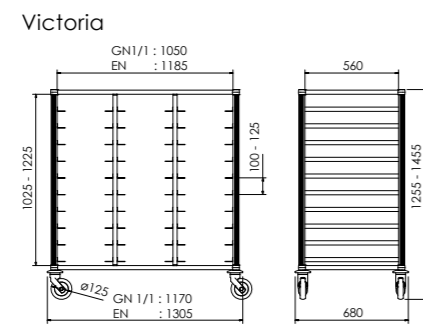

VICTORIA

Overall dimensions				
Height (mm)	Width (mm) GN/EN	Depth (mm)	Qty. of trays Distance between shell 100mm	Qty. of trays Distance between shell 125mm
1255	1170/1305	680	3X10	3X8
1455	1170/1305	680	3X12	3X9



OPTIONS



Compact panel top with 50mm edge | Lateral garbage bag holder | Gallery 150 mm | Lateral foldable work surface



15l lateral container (bacbis) | 30l lateral container (bacbis) | Brake on 2 swivelling wheels | Horizontal steering handle

FINISHES



Light grey Ref xx=09 | Almond look Ref xx=17 | Wenge oak look Ref xx=11 | Black caviar look Ref xx=14



LOBBY

You wish a high quality welcome for your guests; the first impression is made only once.

By listening to you, Ascolia has developed a range of mobile furniture for the reception area to make this first impression an impeccable one.

LUGGAGE

Everest

Luxury luggage trolley

Standard equipment

- Useful width of 900mm
- Large integrated clothes hanger
- Base with carpet (changeable)
- Non-marking wrap-around flexible bumper
- 2 fixed and 2 swivelling wheels Ø200mm,
 - ultra-silent
 - non-marking rubber
- Finishes: natural anodised aluminium, anodised aluminium chrome look, gold anodised aluminium, bright gold anodised aluminium, NEW : anodised aluminium bronze look
- Carpet colors: blue, red, black, brown

Options

- Personalisation of the crown with logo of your establishment
- Centralised brake
- Pneumatic wheels Ø230mm
- Lateral retaining bars
- Protective cover (can be personalised)
- Motorisation, see page 90-91



Everest anodised aluminium bronze look



Everest gold anodised aluminium

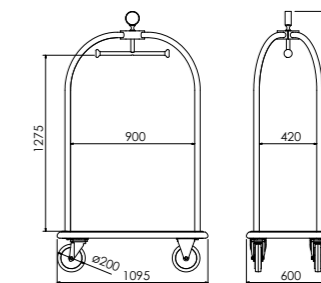

Overall dimensions				
Width (mm)	Depth (mm)	Height (mm)	WheelsØ (mm)	Reference *
1095	600	1890	200	121301 (xx)
Inside dimensions				
Width (mm)	Depth (mm)	Height (mm)		
900	420	1275		



Pneumatic wheel
Ø230mm



Lateral retaining bars



Protection cover

CARPET



Blue Ref (xx)=40



Red Ref (xx)=41

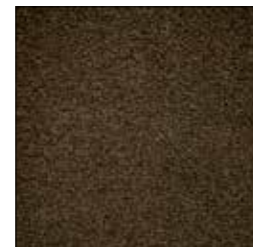

Brown Ref (xx)=43



Black Ref (xx)=42

FINISHES



Silver anodised



Chrome look



Bronze look



Bright gold look



Gold look





e everest natural anodised aluminium

e everest

ASCOLIA WHEELS
YOUR TROLLEY

LESS EFFORT, MORE JOY!

The ergonomic controller allows you an easy and intuitive use

Characteristics

- Progressive and silent acceleration
- Safety of use
- Great manoeuvrability; pivots on the spot
- Charging time : 7 hours
- CE certification



LUGGAGE

Vesuvio

Group luggage trolley, a great classic

Standard equipment

- 3 useful widths: 750, 900 and 1100mm
- Integrated clothes hanger
- Base with carpet (changeable)
- Non-marking wrap-around flexible bumper
- 2 fixed and 2 swivelling wheels Ø200mm, ultra-silent, non-marking rubber
- Finishes: natural anodised aluminium, gold anodised aluminium
- Carpet colors: blue, red, black, brown

Options

- Personalisation of the crowns with logo of your establishment
- Centralised brake
- Pneumatic wheels Ø230mm
- Protective cover (can be personalised)
- Motorisation



Vesuvio natural anodised aluminium

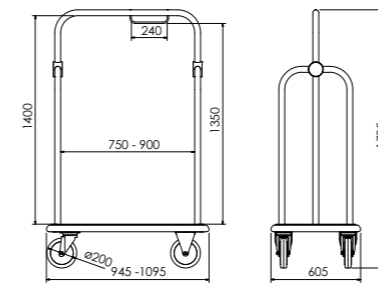

FINISHES



Silver anodised



Gold look



Vesuvio gold anodised aluminium

CARPET



Blue Ref (xx)=40

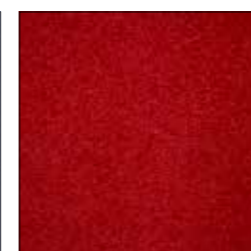

Red Ref (xx)=41

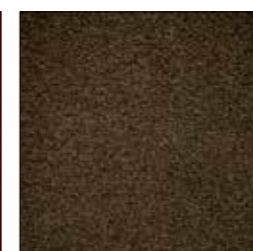

Brown Ref (xx)=43

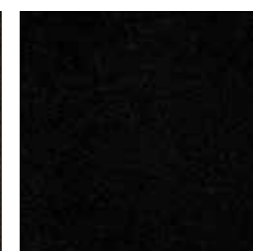

Black Ref (xx)=42

VESUVIO 750

Overall dimensions				
Width (mm)	Depth (mm)	Height (mm)	WheelsØ (mm)	Reference *
945	605	1735	200	120501xx
Inside dimensions				
Width (mm)	Height (mm)			
750	1350			

VESUVIO 900

Overall dimensions				
Width (mm)	Depth (mm)	Height (mm)	WheelsØ (mm)	Reference *
1095	605	1735	200	120701XX
Inside dimensions				
Width (mm)	Height (mm)			
900	1350			

VESUVIO 1100

Overall dimensions				
Width (mm)	Depth (mm)	Height (mm)	WheelsØ (mm)	Reference *
1295	605	1735	200	120901XX
Inside dimensions				
Width (mm)	Height (mm)			
1100	1350			

LUGGAGE

Fuji

Elegance and refinement.
Reduced space

Standard equipment

- 2 useful widths: 750 and 900mm
- Integrated clothes hanger
- Base with carpet (changeable)
- Non-marking wrap-around flexible bumper
- 2 fixed and 2 swivelling wheels Ø200mm, ultra-silent, non-marking rubber
- Finishes: natural anodised aluminium, gold anodised aluminium
- Carpet colors: blue, red, black, brown

Options

- Personalisation of the crowns with logo of your establishment
- Centralised brake
- Pneumatic wheels Ø230mm
- Protective cover (can be personalised)



Fuji natural anodised aluminium

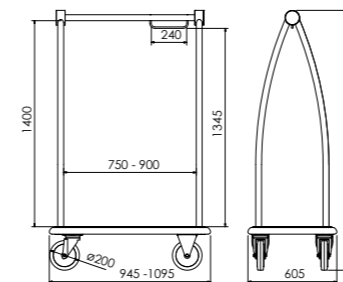

FINISHES



Silver anodised

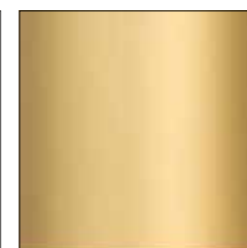

Gold look



Fuji gold anodised aluminium

CARPET



Blue Ref (xx)=40

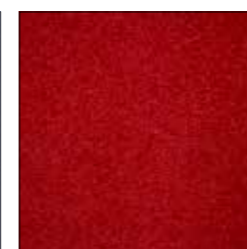

Red Ref (xx)=41



Brown Ref (xx)=43

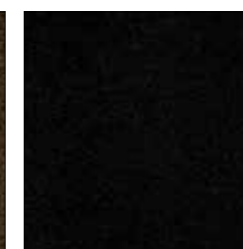

Black Ref (xx)=42



Protection cover

FUJI 750

Overall dimensions				
Width (mm)	Depth (mm)	Height (mm)	Wheels Ø (mm)	Reference *
945	605	1760	200	120101xx
Inside dimensions				
Width (mm)	Height (mm)			
750	1345			

FUJI 900

Overall dimensions				
Width (mm)	Depth (mm)	Height (mm)	Wheels Ø (mm)	Reference *
1095	605	1760	200	120301xx
Inside dimensions				
Width (mm)	Height (mm)			
900	1345			

LUGGAGE

Vulcano

Elegance and refinement.
Reduced space

Standard equipment

- Sturdy base including carpet (blue, red, black or brown)
- Grey non marking wrap around bumper
- 2 fixed and 2 swivelling wheels Ø 200 mm

Options

- Centralised brake
- Pneumatic wheels Ø 230 mm
- Finishes : silver anodised or gold anodised



Vulcano gold anodised aluminium



FINISHES



Silver anodised

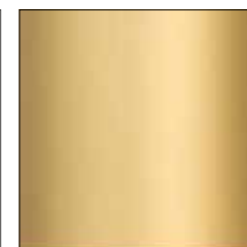

Gold look

CARPET



Blue Ref (xx)=40



Red Ref (xx)=41



Brown Ref (xx)=43

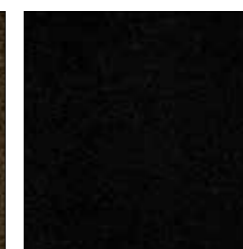

Black Ref (xx)=42

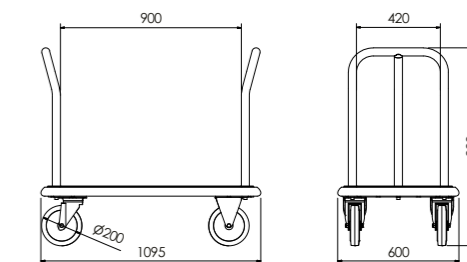

VULCANO

Overall dimensions				
Width (mm)	Depth (mm)	Height (mm)	Wheels Ø (mm)	Reference *
1095	600	980	200	122301xx
Inside dimensions				
Width (mm)	Height (mm)			
420	900			

LUGGAGE

Stromboli

Standard equipment

- Aluminium hand truck
- Delivered with a shovel
- 2 comfort wheels Ø260mm in micro cellular foam

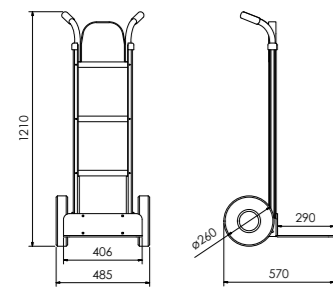

Options

- Tubular extension
- Pair of support legs



Ubinas

Standard equipment

- Anodised aluminium hand truck
- Removable and washable carpet
- Foldable extension
- 2 comfort wheels Ø260mm in micro cellular foam
- Finishes: natural anodised aluminium, gold anodised aluminium
- Carpet colors: blue, red, black, brown

Options

- Pair of support legs

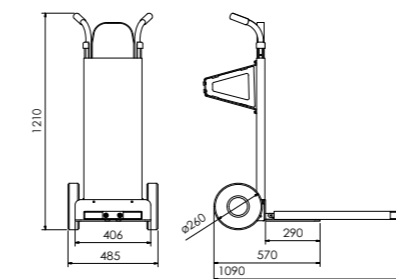

Comfort wheel Ø260mm in micro cellular foam



GUIDANCE

Luxor

Standard equipment

Standard equipment

- Guidance pole in stainless steel
- Multi-directional head allows for ropes to be attached in multiple directions
- Large weighted base provides excellent stability (8kg)
- Finishes: chromed, nickel mat or brass



Crown

Classic and elegant for luxury reception venues

Standard equipment

- Guidance pole in stainless steel
- Multi-directional head allows for ropes to be attached in multiple directions
- Large weighted base provides excellent stability (8kg)
- Finishes: chromed or brass

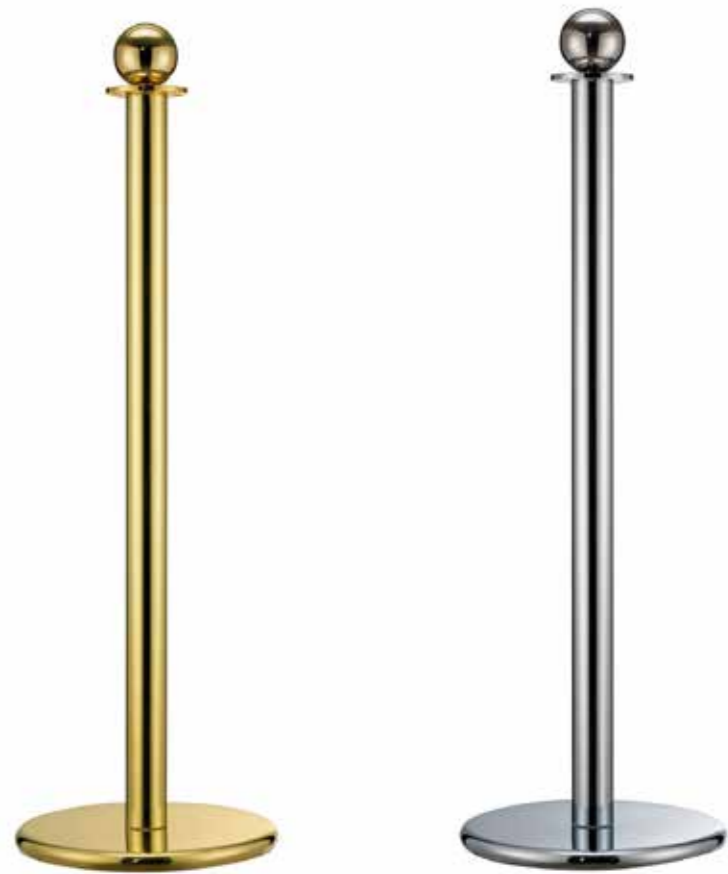

GUIDANCE

Abydos

Belt system

Standard equipment

- 2.3m self-restrained belt
- 1 rope and 3 connection points
- Large weighted base (9kg) with anti-slip and non-marking rubber
- Finishes: chromed, brass, or stainless steel

Options

- Belt 3.7m
- Belt personalisation with logo and/or text



Dikos

Information panel with aluminium frame

Standard equipment

- 2 formats: A4 (210 x 297 mm) or A3 (420 x 297 mm) horizontal or vertical
- Finishes : chromed, nickel mat or brass
- For use on Luxor or Abydos poles only



Dikos information panel on Luxor pole



Head office

ASCOLIA

Bergensesteenweg, 308
B-1600 Sint Pieters Leeuw
Belgium
Tel +32 2 378 21 31

France

ARIANEL

15, rue Jean Zay
F-69800 Saint Priest
France
Tel +33 4 72 28 40 30

Spain

TRM

Calle Narvaez, 35
28009 Madrid
Espana
Tel +34 639 122 765

UAE

ASCOLIA ME

Suite 805 OPAL Tower
Burj Khalifa Boulevard. Business Bay.
Dubai, UAE
Tel +971 50 9245100